

Contents



Welcome Unit
Back to School 4

Unit 1
People at School 9

Unit 2
I can! 17

Unit 3
Places in Town 25

Unit 4
My House 33

Unit 5
Signs Around Me 41

Unit 6
Going on Vacation 49

Unit 7
Feelings 57

Unit 8
The Desert 65

Picture Dictionary 73

Stickers 81



Back to School



First Day Fun





Look, listen, and mark.

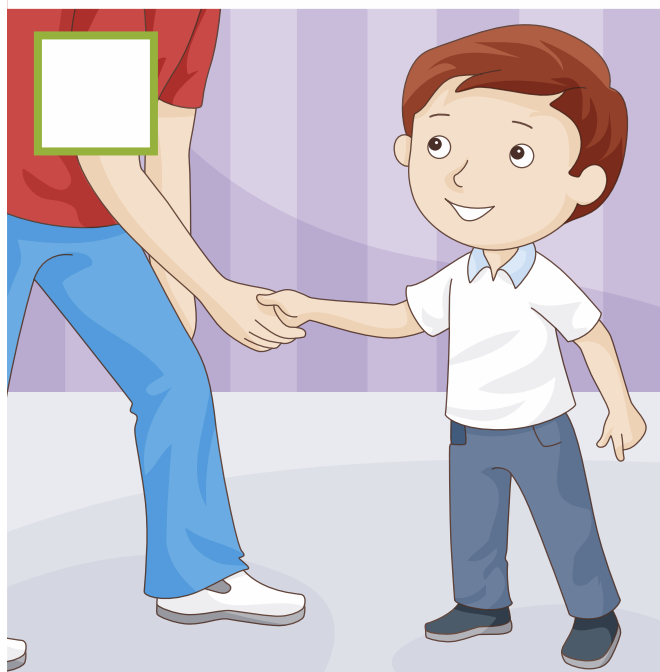



Look, draw, and sing.

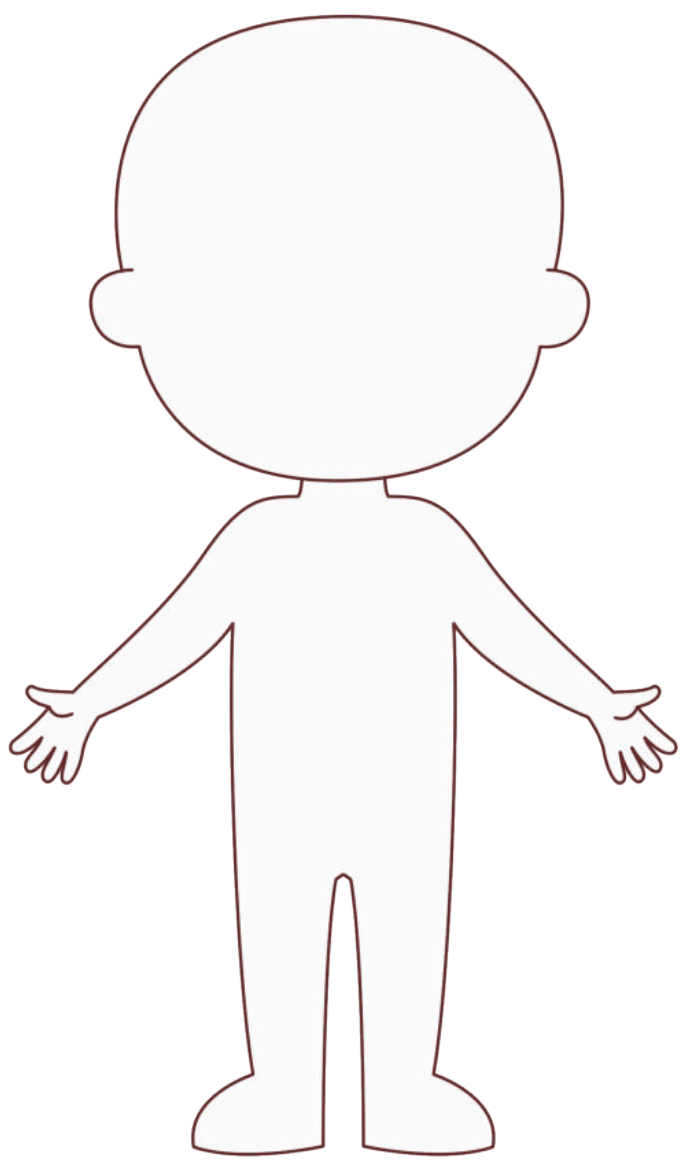
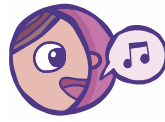

My name is _____.



Draw, trace, and say.

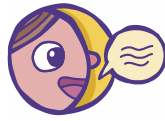

classroom



People at School

1



teacher



janitor

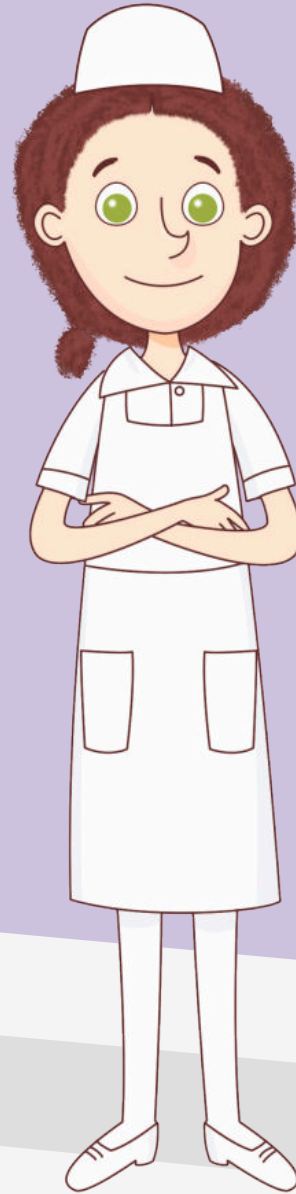

nurse



principal

Where's Henry?





Attach the stickers and say.

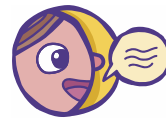



Listen, trace, and match.

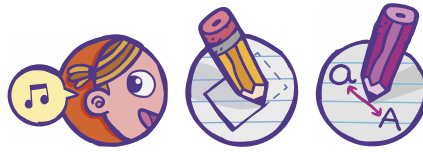

teacher

boy



nurse

girl



Trace, count, and circle.





Trace, draw, and say.

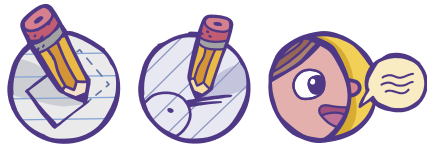

teacher

principal



Cut and make.

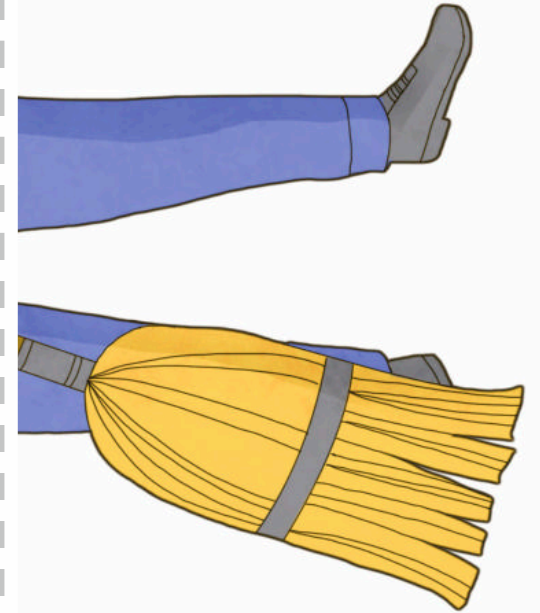
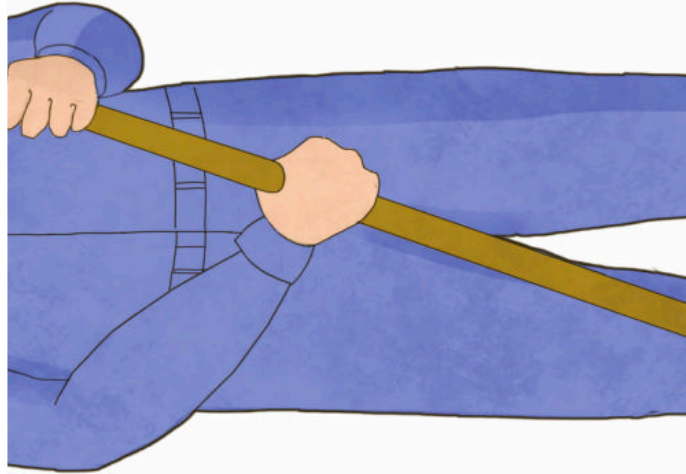
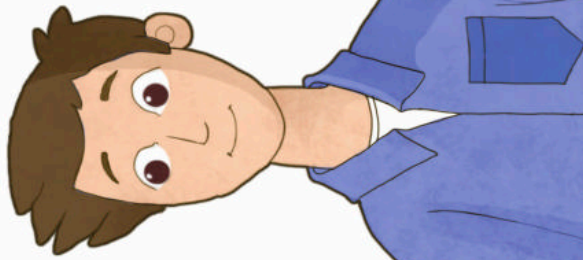
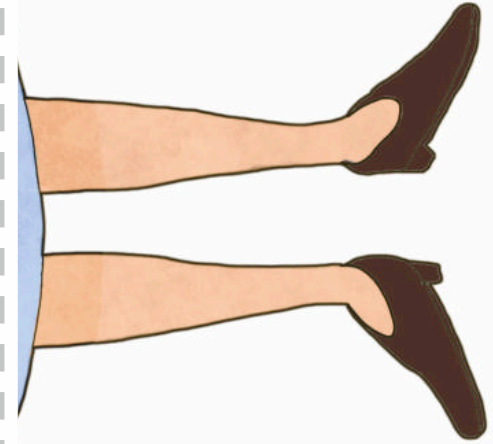
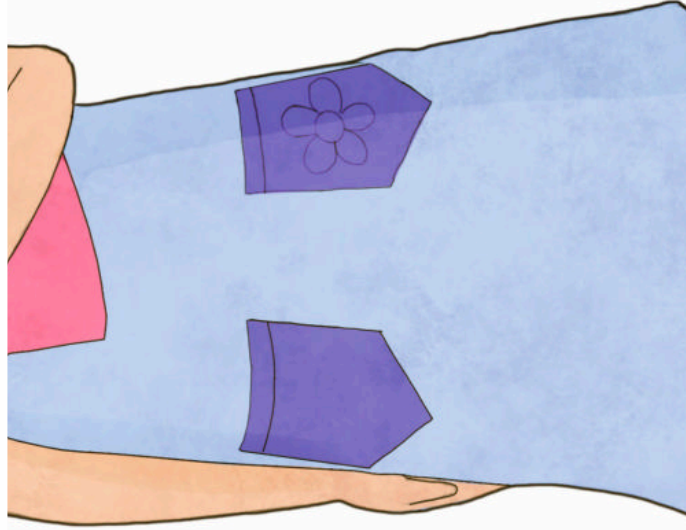
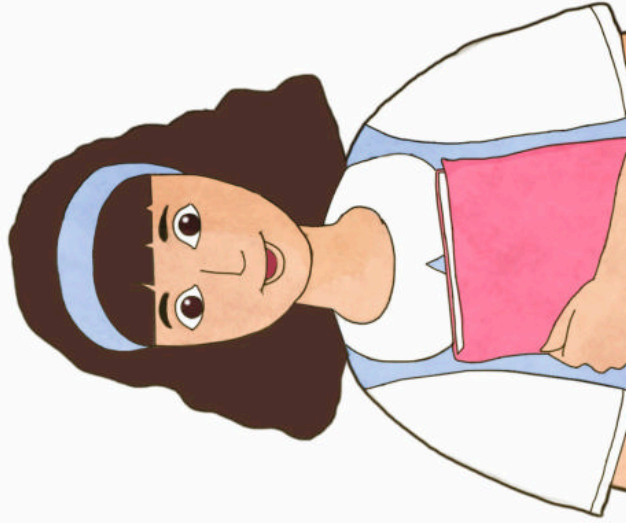



1

Unit

I can!

2



play



run



jump



draw

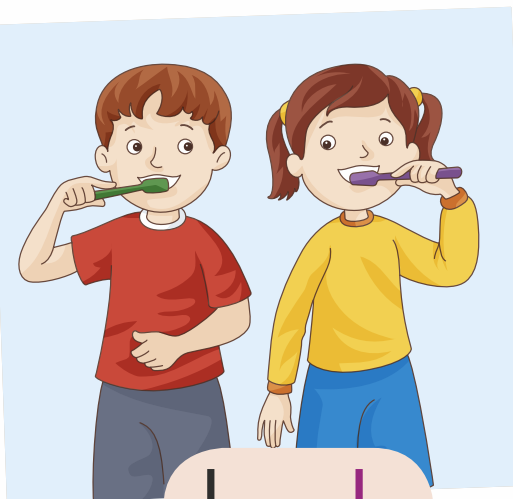

brush



water

Field Day





Attach the stickers and say.



Page 83

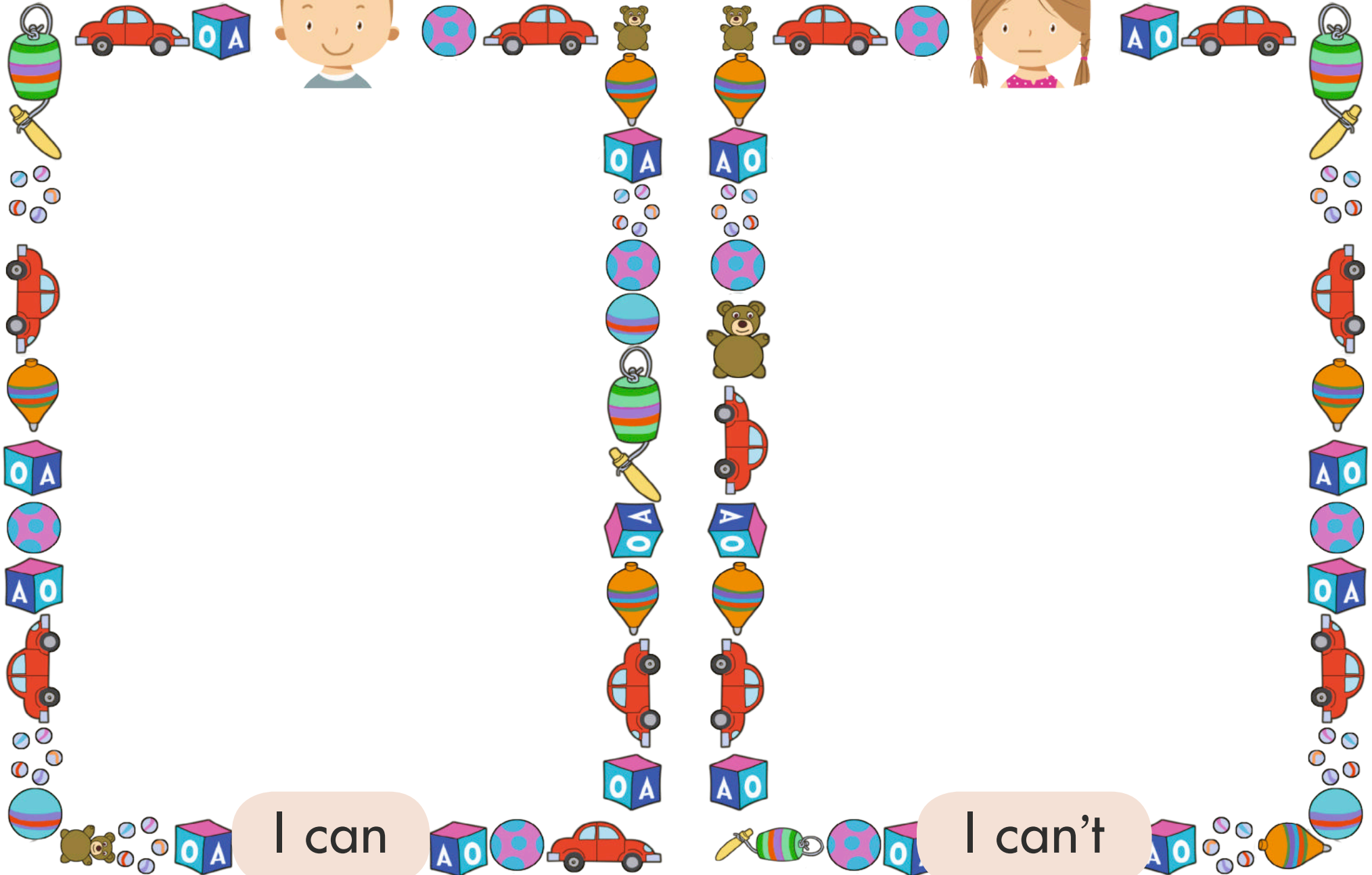
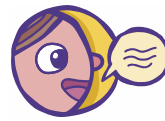



Trace, listen and match.



jump

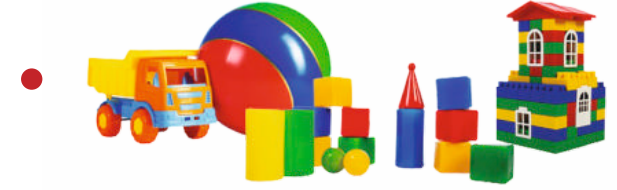

water



run



play





Count, trace, and say.

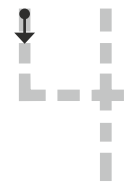
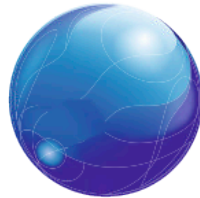
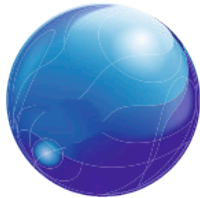
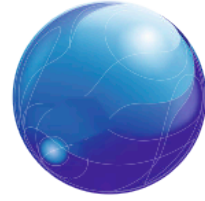
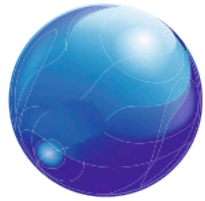
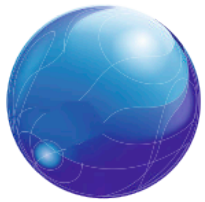
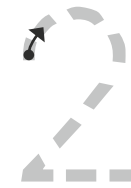



Look, draw, and say.

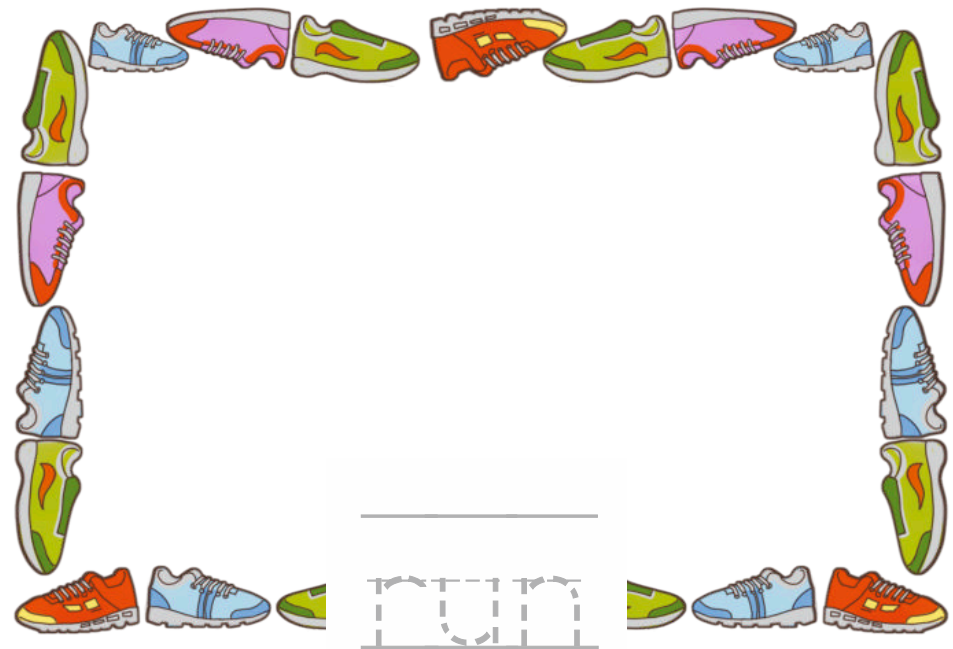
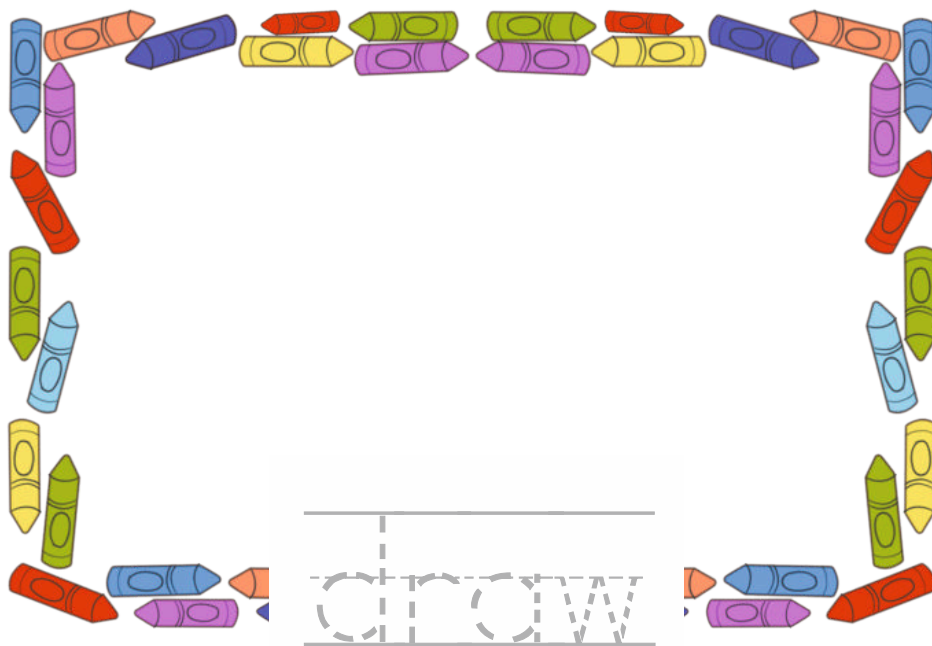
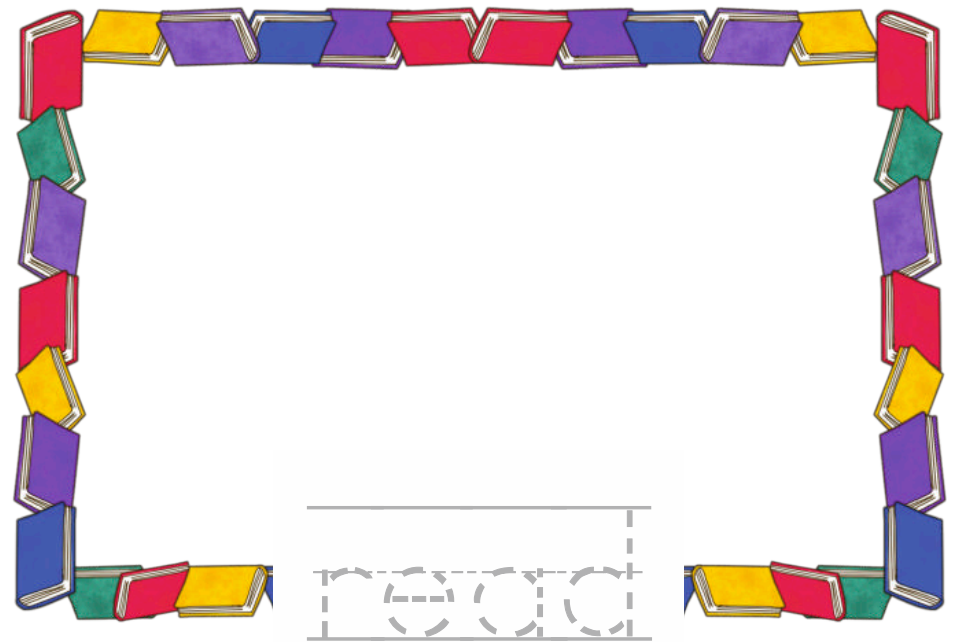
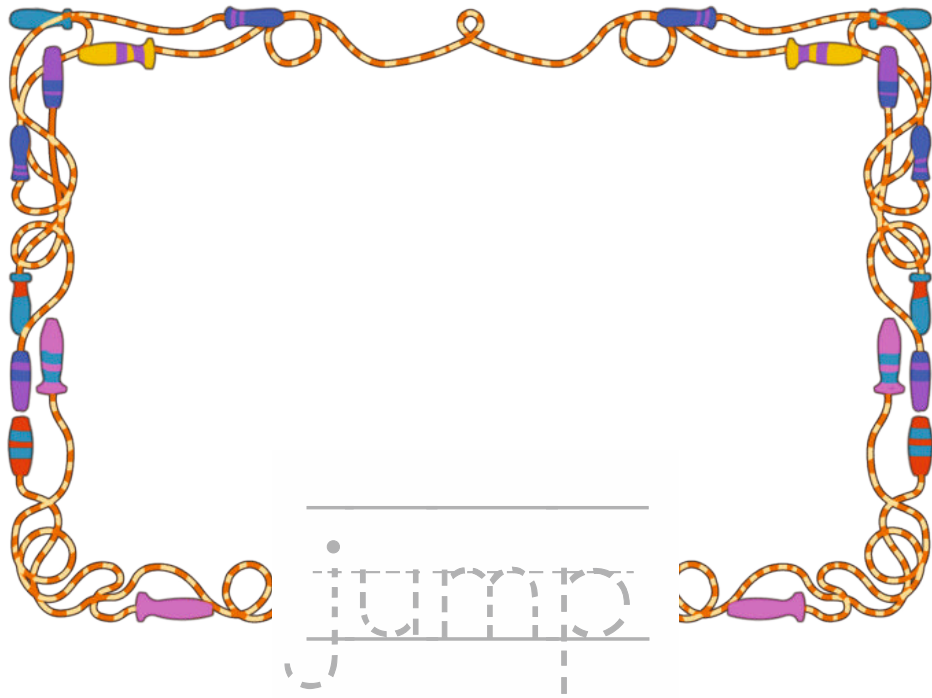
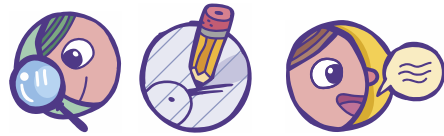



Cut, make, and play.

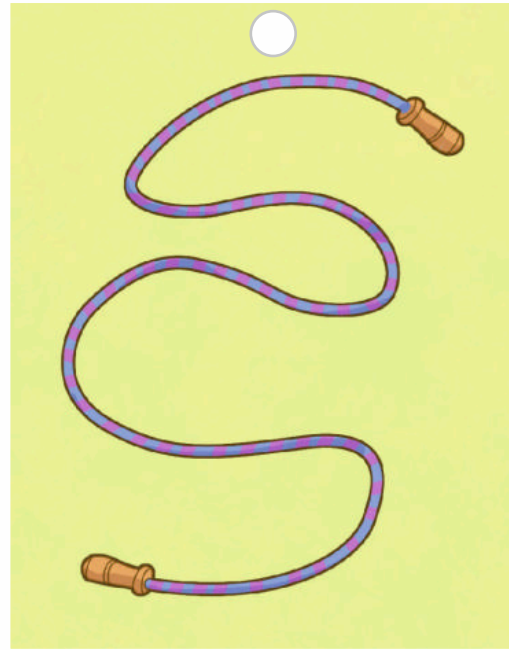

I can!





2

Unit



Places in Town 3



Family Day





Attach the stickers and say.

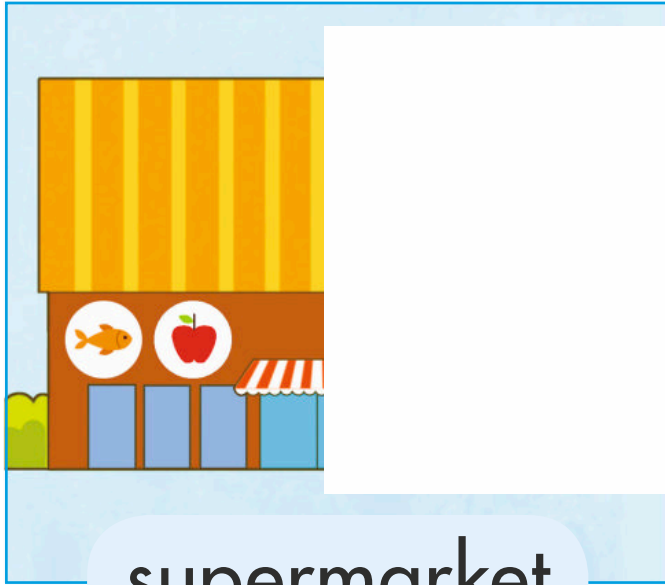

supermarket

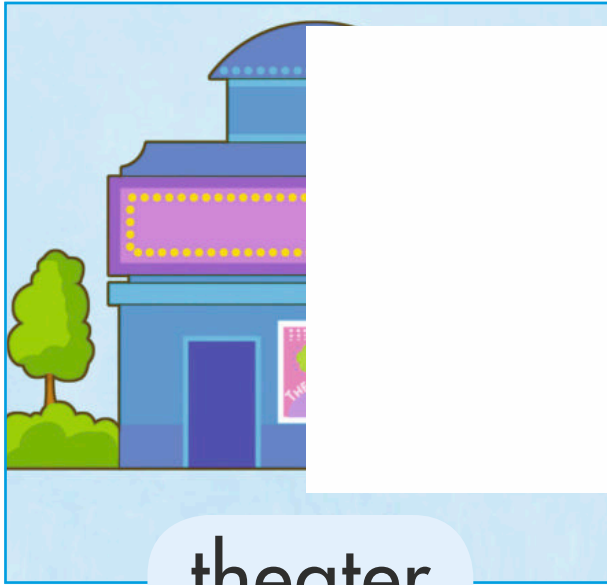

theater



hospital

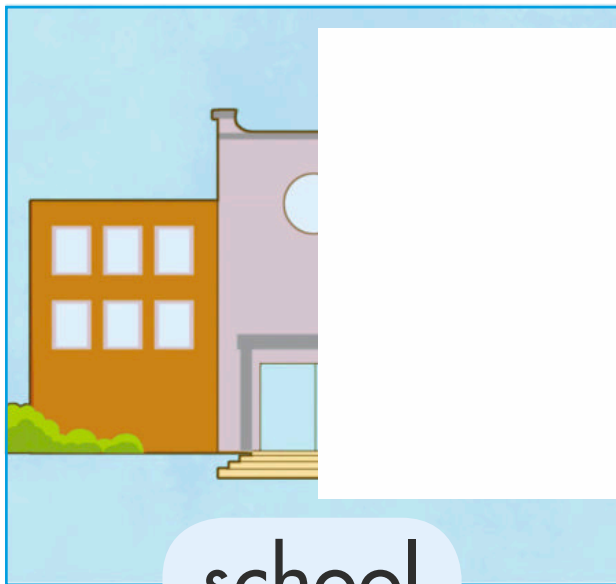

school

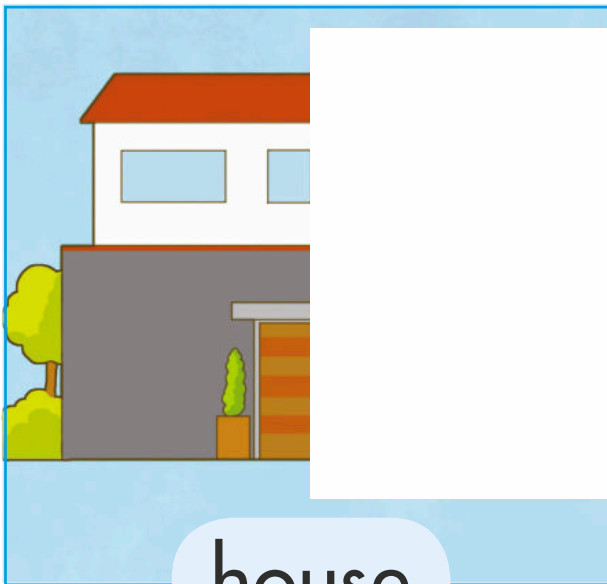

house

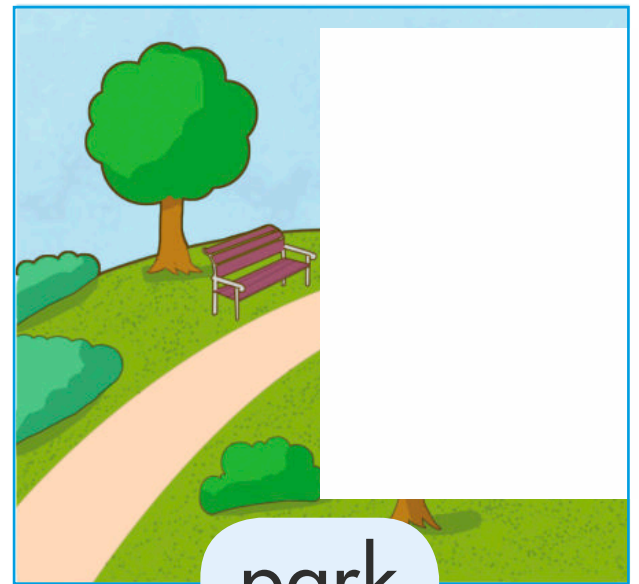

park



Listen and mark.

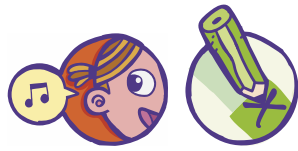

1

Handwriting practice for the letter 'D'. The left panel shows a dashed 'D' on a four-line grid with a directional arrow indicating the stroke direction. The right panel shows a blank grid for practice. Below the left panel is a green icon of a tree and bench. Below the right panel is a red icon of a house.

2

Handwriting practice for the letter 'S'. The left panel shows a dashed 'S' on a four-line grid with a directional arrow indicating the stroke direction. The right panel shows a blank grid for practice. Below the left panel is a blue icon of a shopping cart. Below the right panel is a green icon of a stethoscope.

3

Handwriting practice for the letter 'S'. The left panel shows a blank grid for practice. The right panel shows a dashed 'S' on a four-line grid with a directional arrow indicating the stroke direction. Below the left panel is a green icon of a stethoscope. Below the right panel is a grey icon of a house.

4

Handwriting practice for the letter 'R'. The left panel shows a dashed 'R' on a four-line grid with a directional arrow indicating the stroke direction. The right panel shows a blank grid for practice. Below the left panel is a purple icon of a fork and plate. Below the right panel is a red icon of a house.



Count, trace, and color.

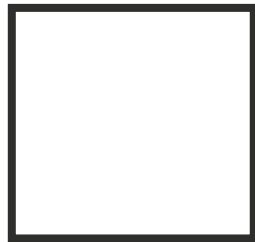
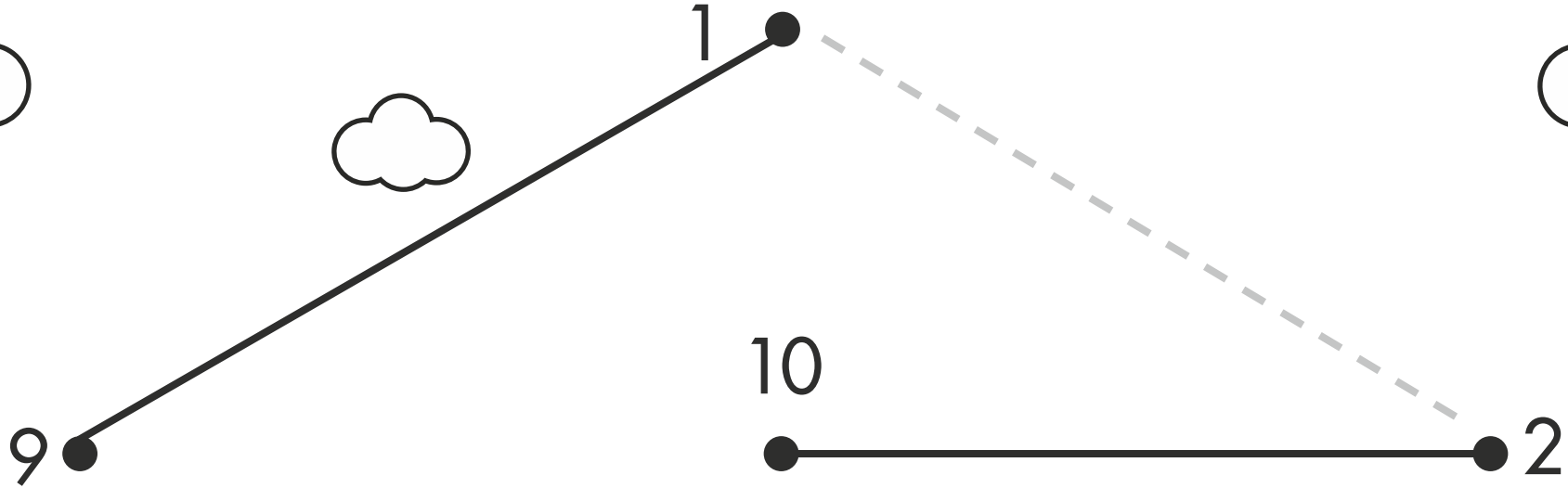

8 ●

● 3

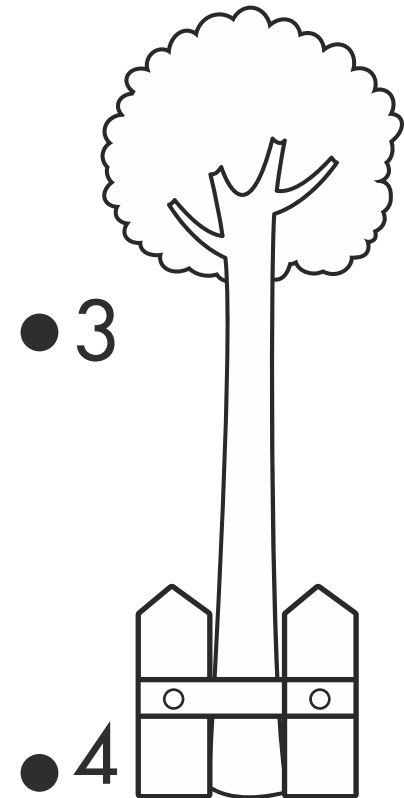
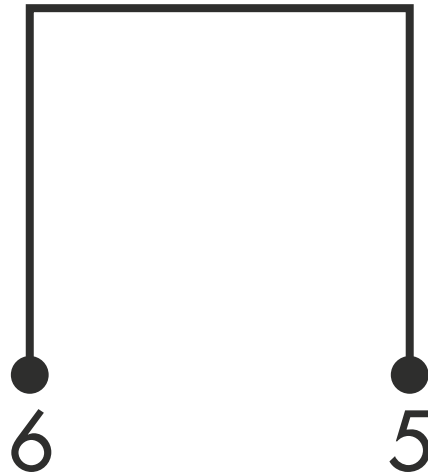
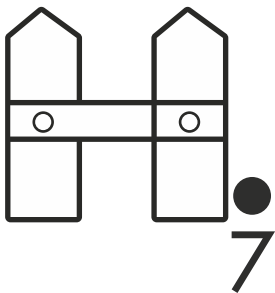



Trace, draw, and say.

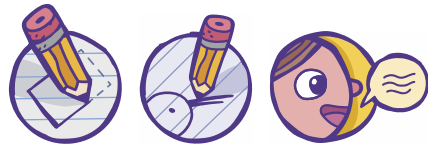



Cut, glue, and play.

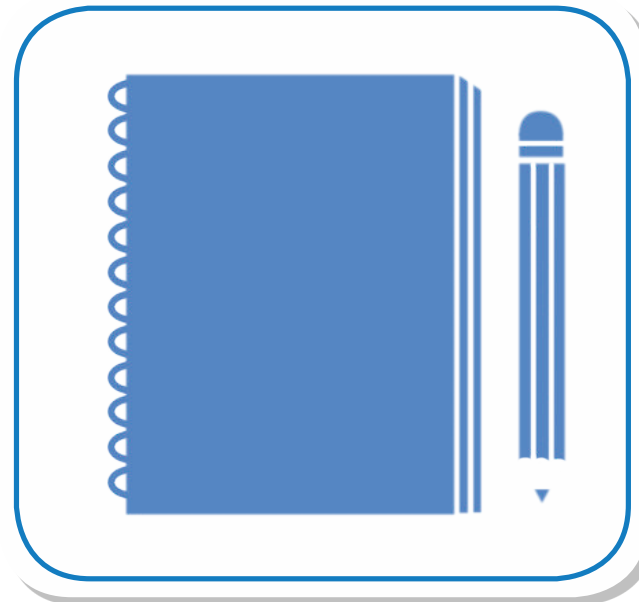



3

Unit



My House

4

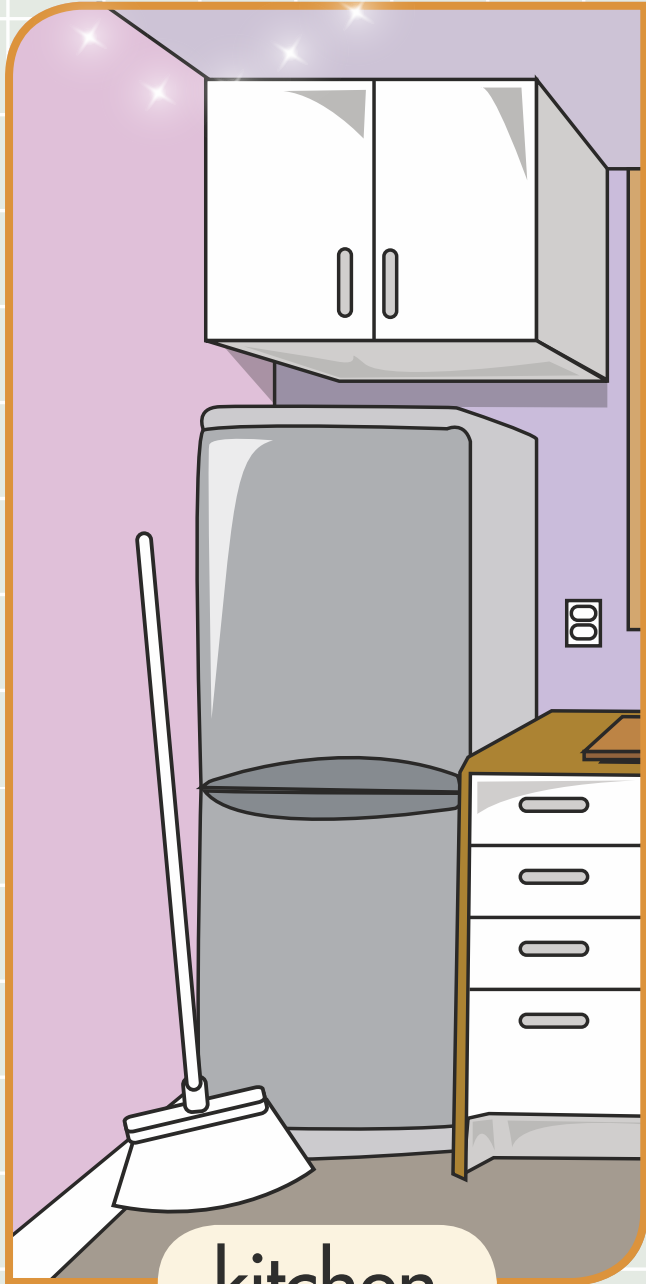

kitchen

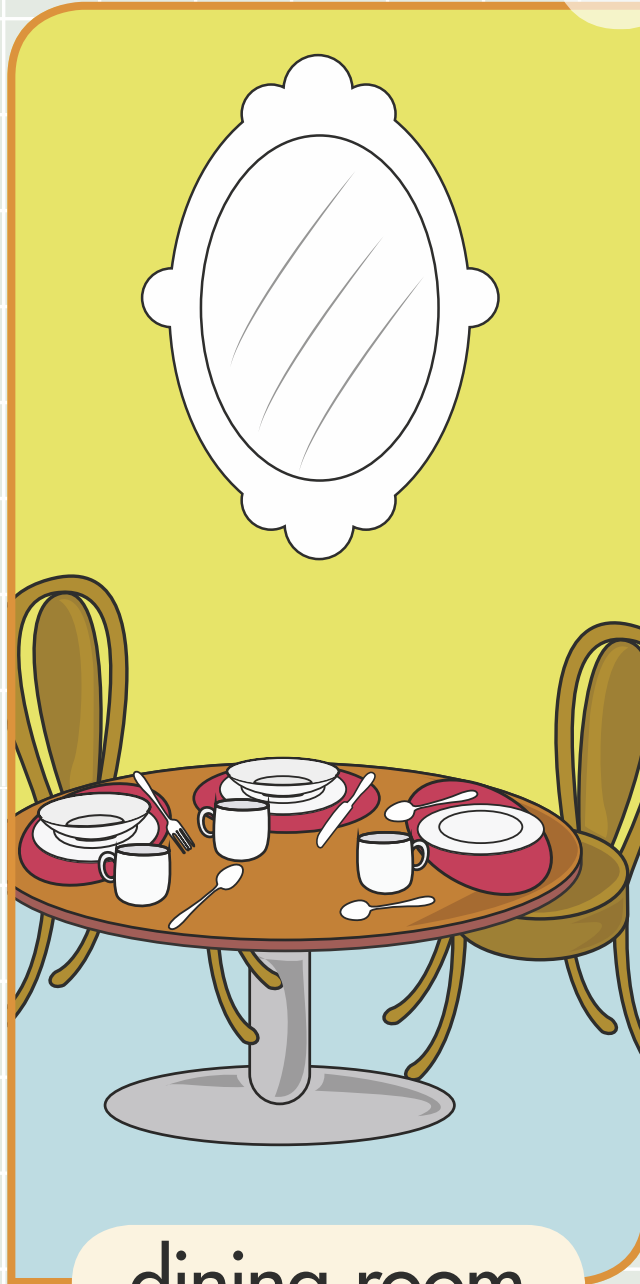

dining room

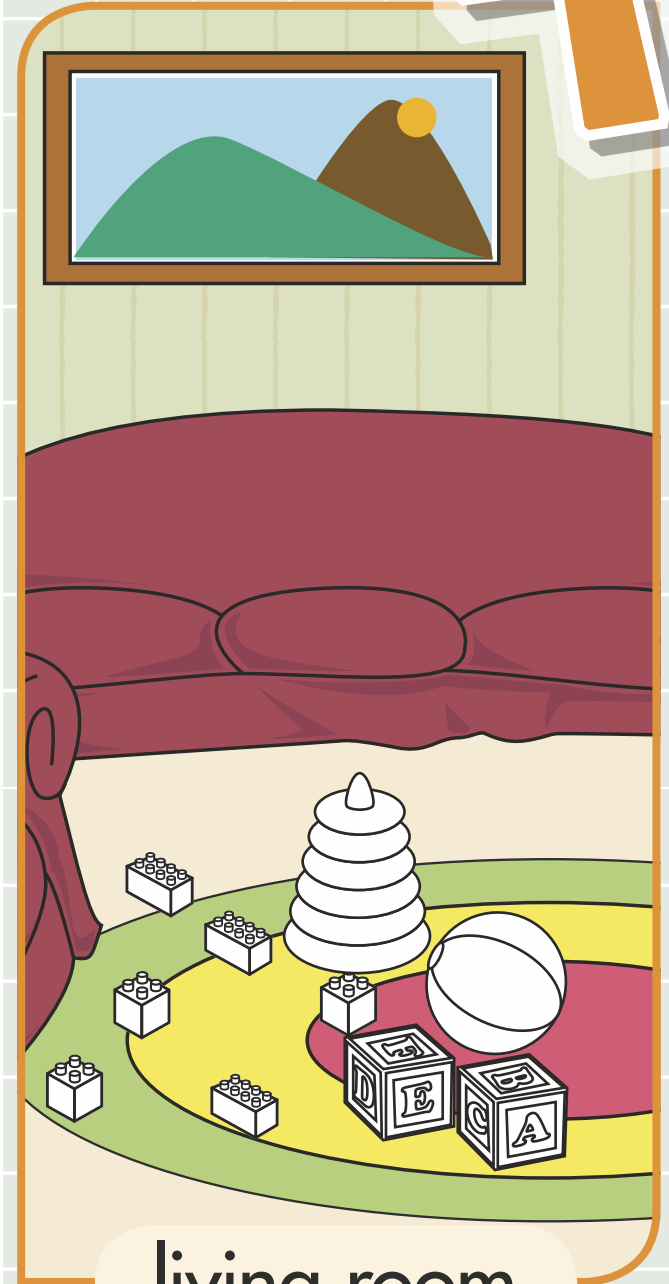

living room

Surprise!





Attach the stickers and say.

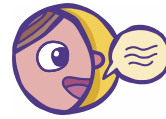

living room



dining room



kitchen



bedroom



Listen, circle, and say.



1



closet



sink



cup

2



broom



bed



mirror

3



plate



toys



TV



Draw, count, and write.



My Bedroom

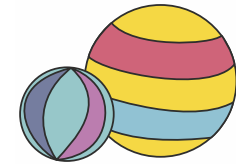

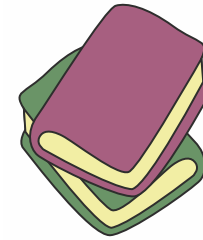









Read, circle, and say.



dining room



living room



kitchen



bathroom



bedroom





Color, cut, and play.

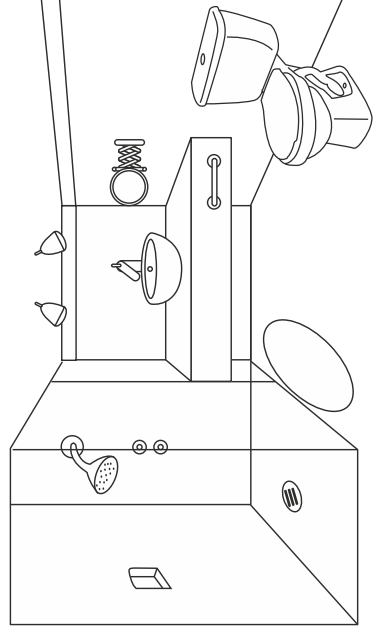
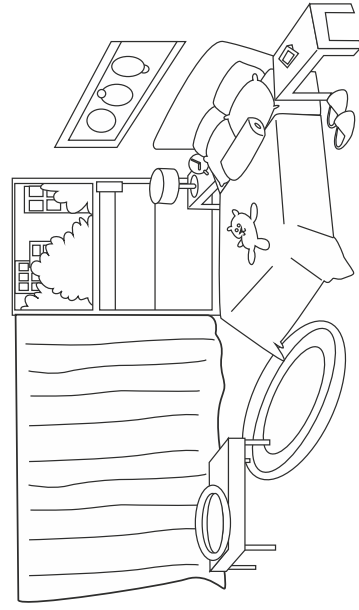
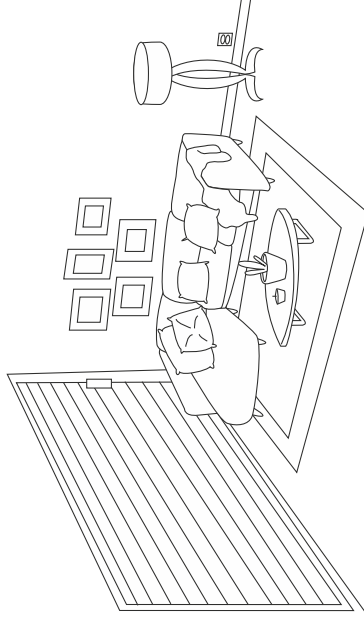
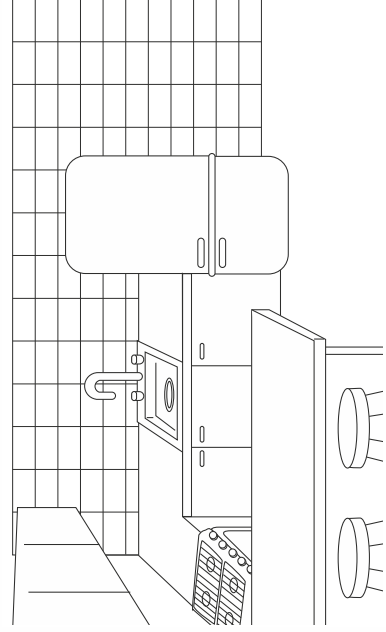
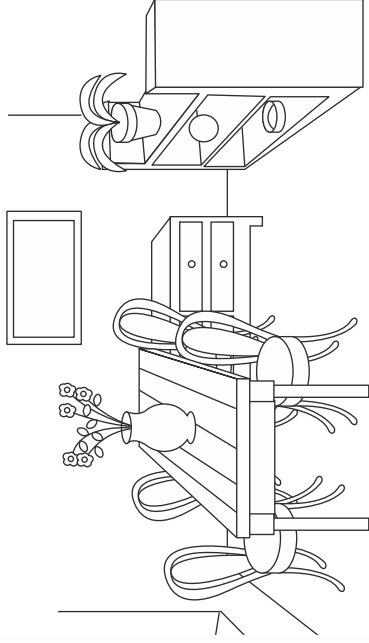

dining room

kitchen

living room

bedroom

bathroom





4

Unit

Signs Around Me

5



At the Museum

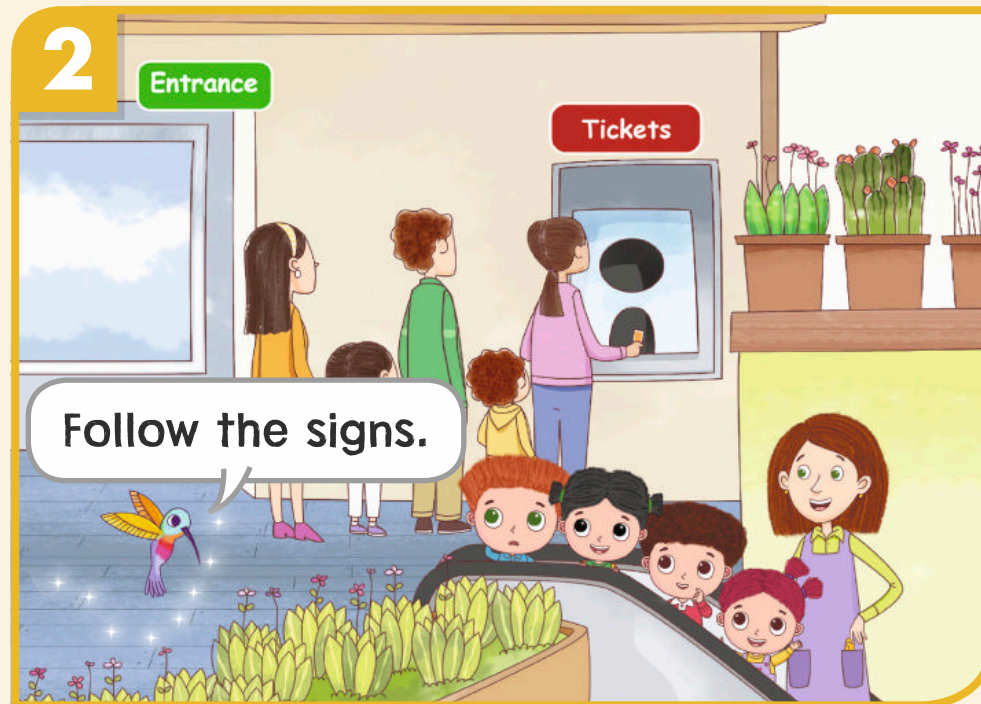



Attach the stickers and say.



Page 89

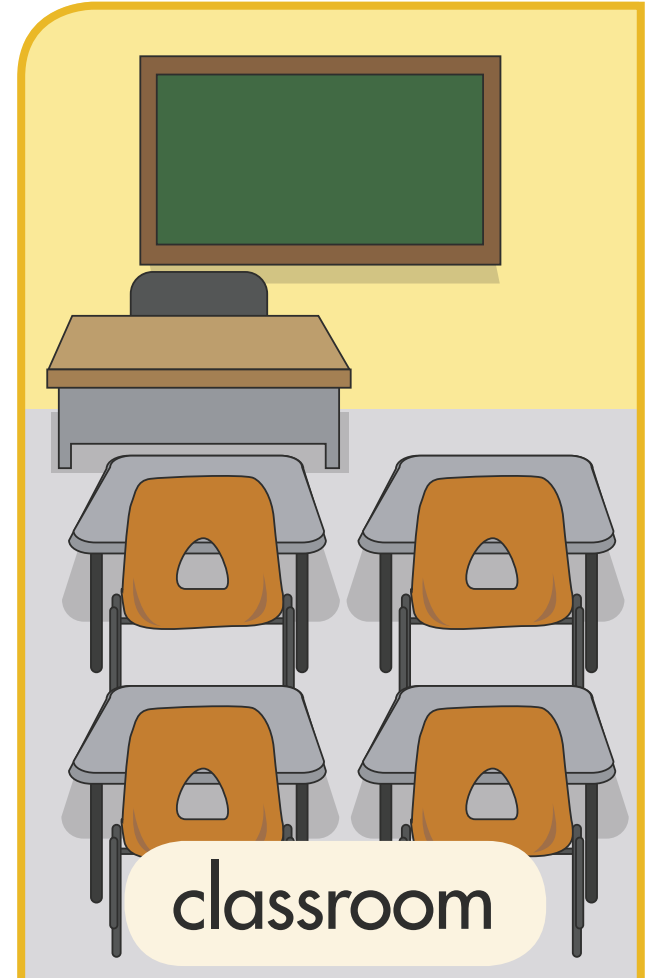
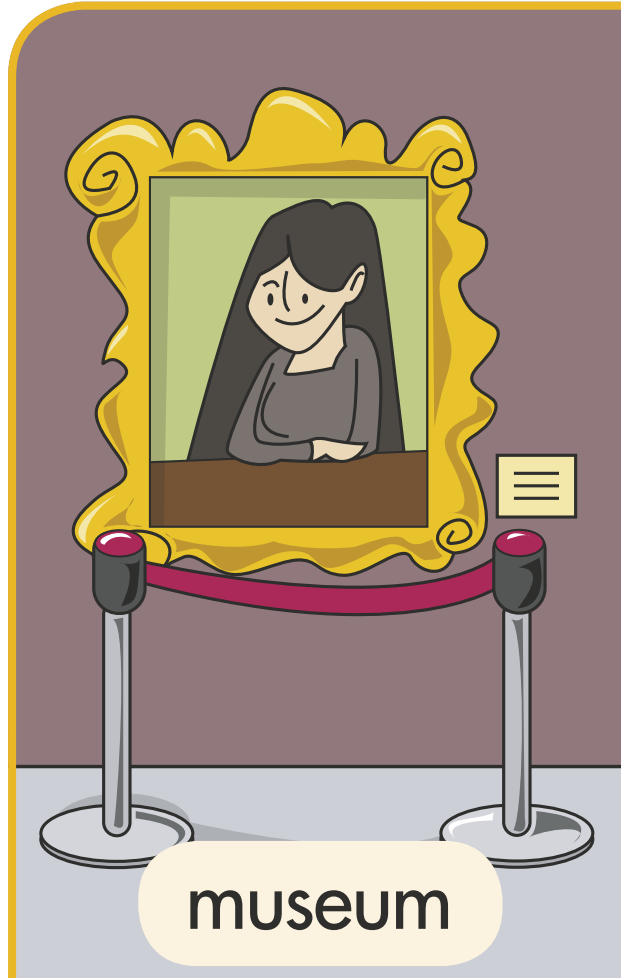
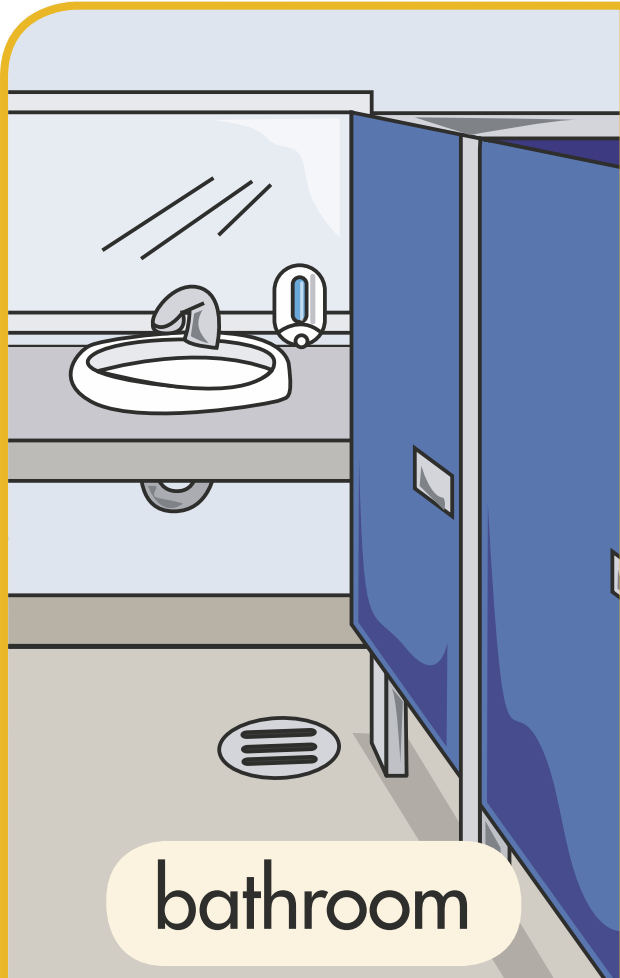
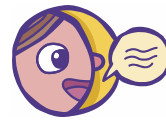



Trace, listen, and circle.



stop



silence



exit

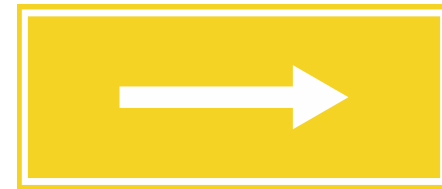
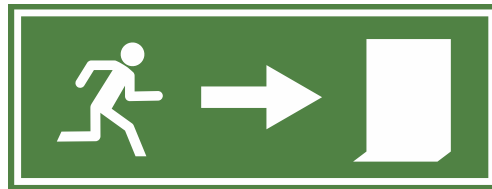



Trace, count, and color.

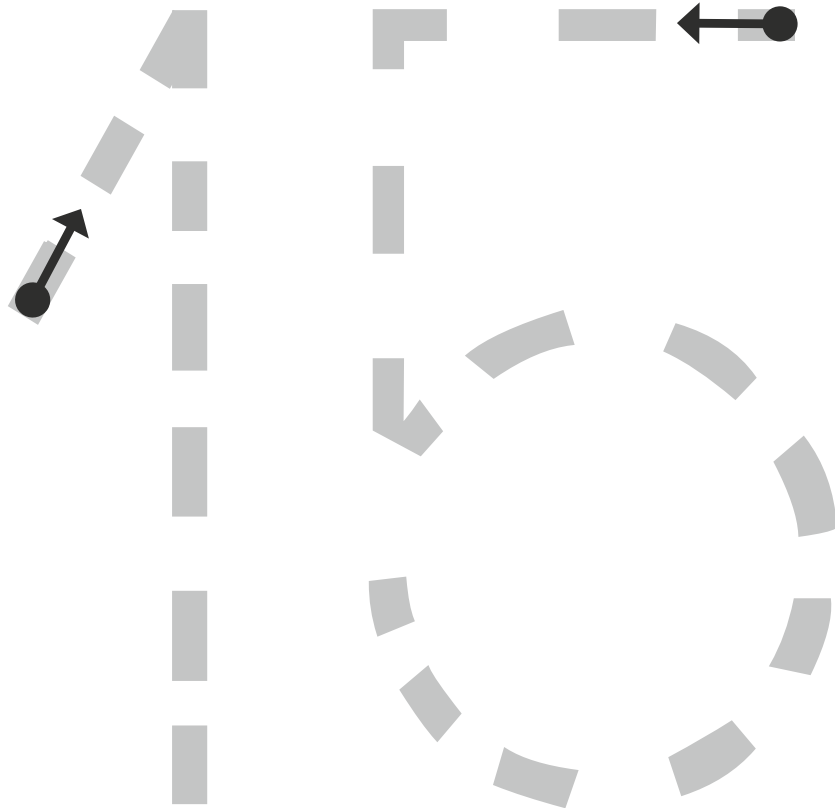

fifteen

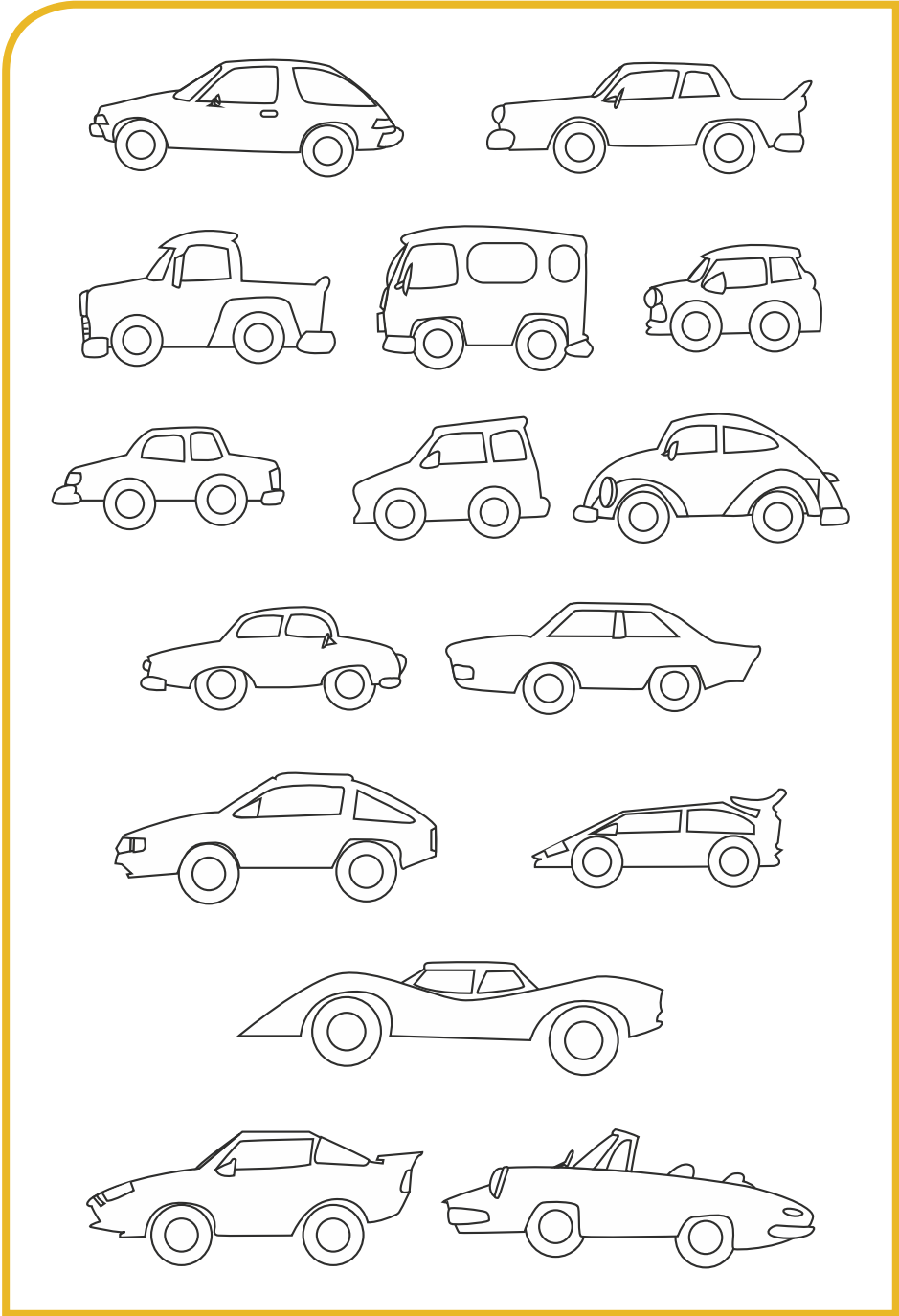



Look, say, and play.

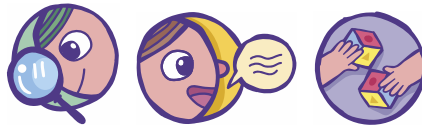

START



FINISH





Cut, glue, and play.

