

Contents



Unit 1	Our School	4
Unit 2	Me	10
Unit 3	Home and Family	16
Unit 4	My Abilities	22
Unit 5	Weather	28
Unit 6	Animal Habitats	34
Unit 7	Mealtime	40
Unit 8	Our Planet	46
Unit 9	The Circus	52
Unit 10	People at Work	58
Unit 11	A Walk in the Country	64
Unit 12	City and Vehicles	70
Unit 13	My Town	76
Unit 14	A Play Date	82
Unit 15	Caring for my Town	88
Holidays	94
Stickers	97





Look and color.

Room 3

Bathroom

Nurse's Office



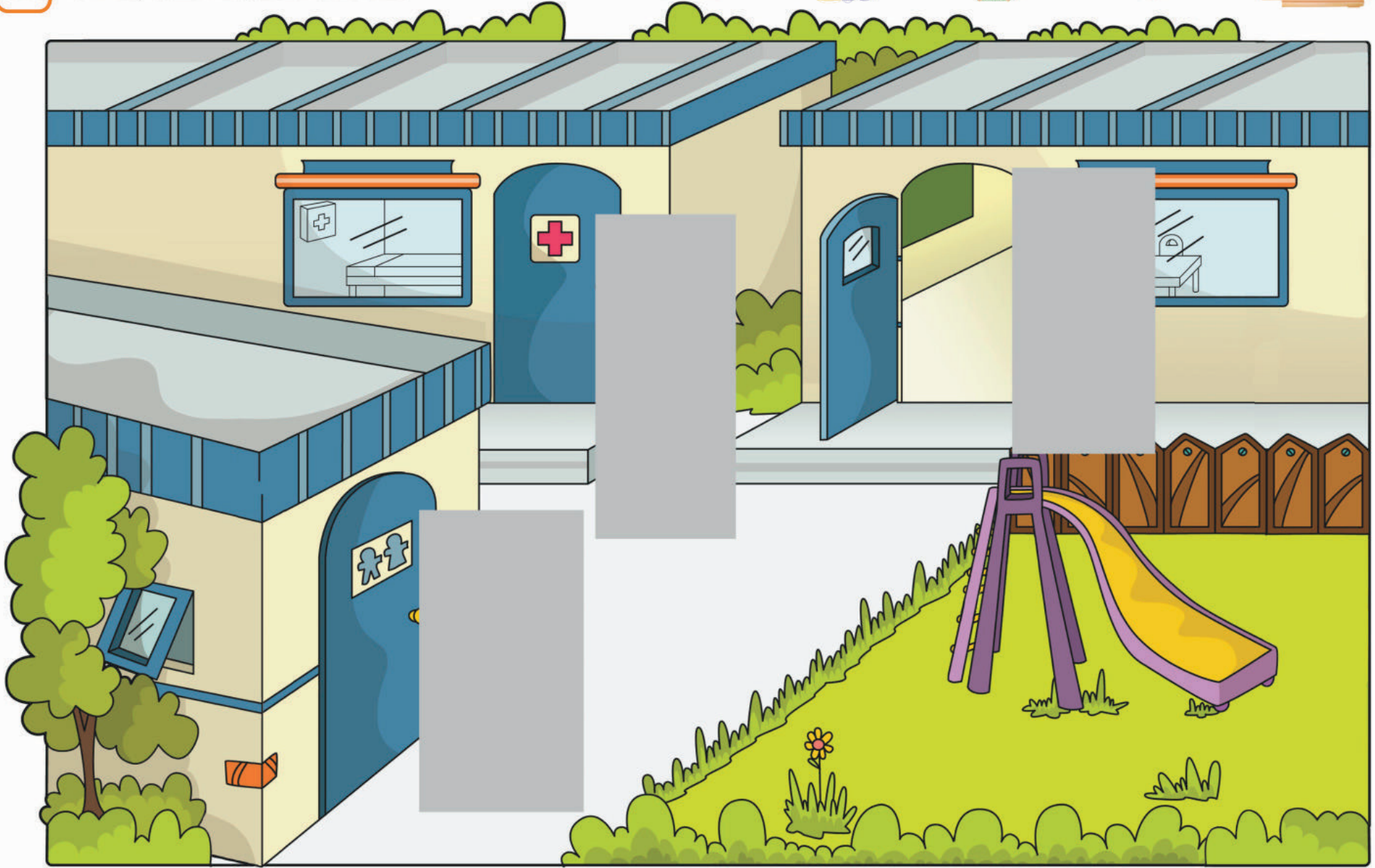

nurse

janitor

teacher



Draw and find.





Look, match, and trace.

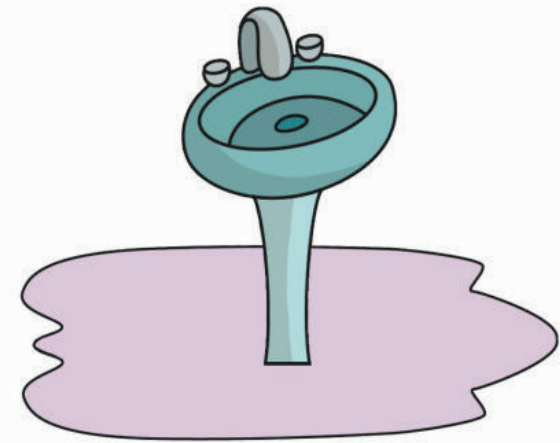
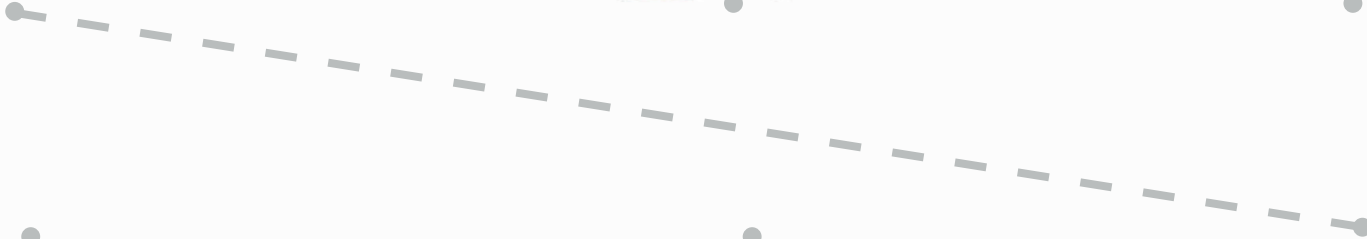

eat

play

wash



Connect and color.

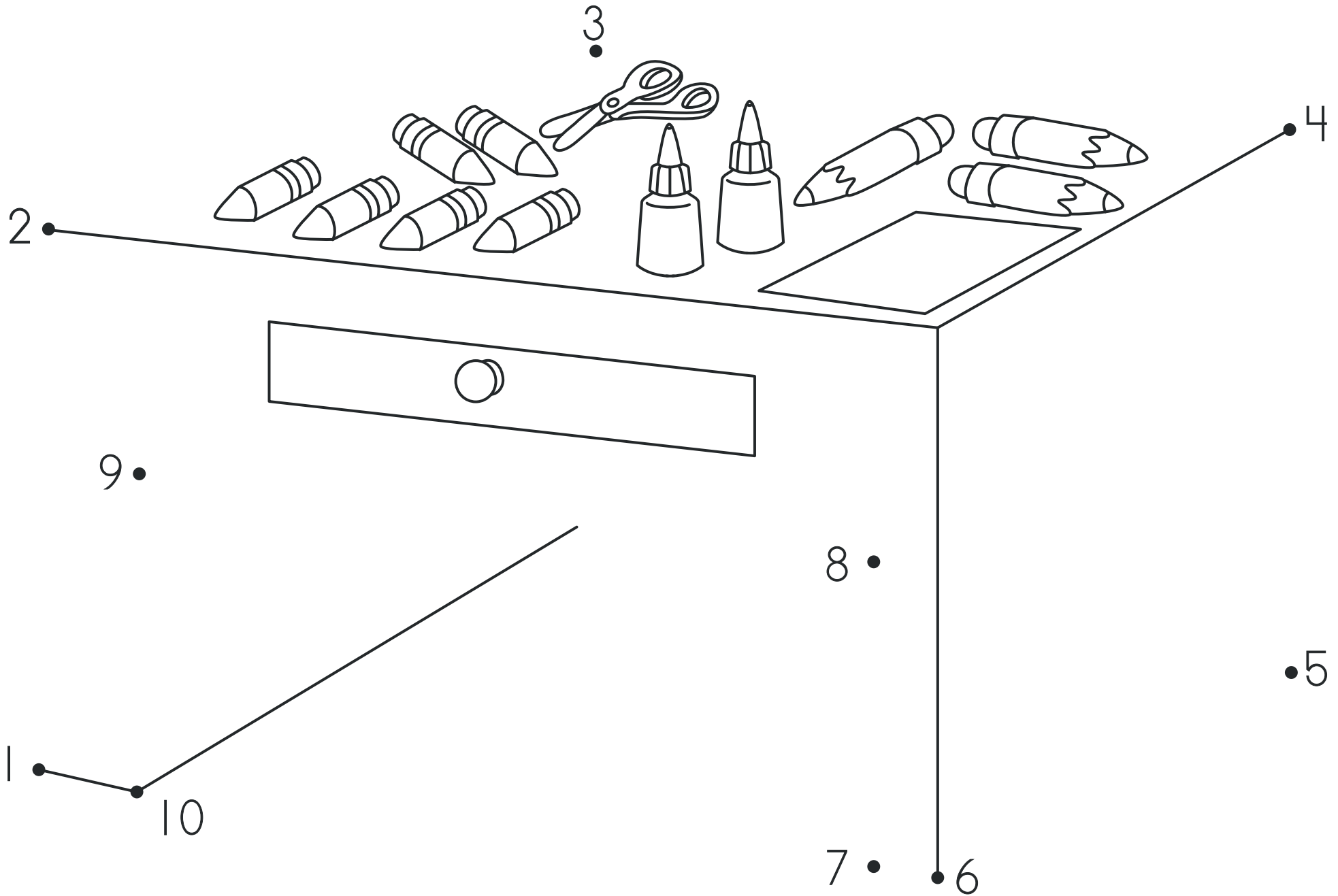

Unit 1 Lesson 5

Let's count!





Draw and describe.



My School

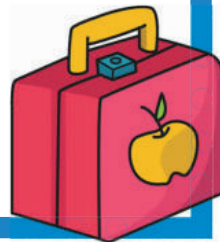
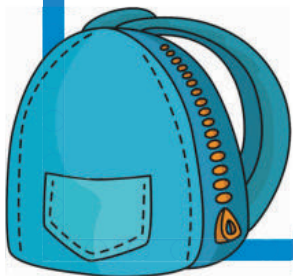
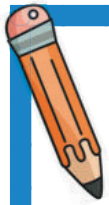



Color and trace.

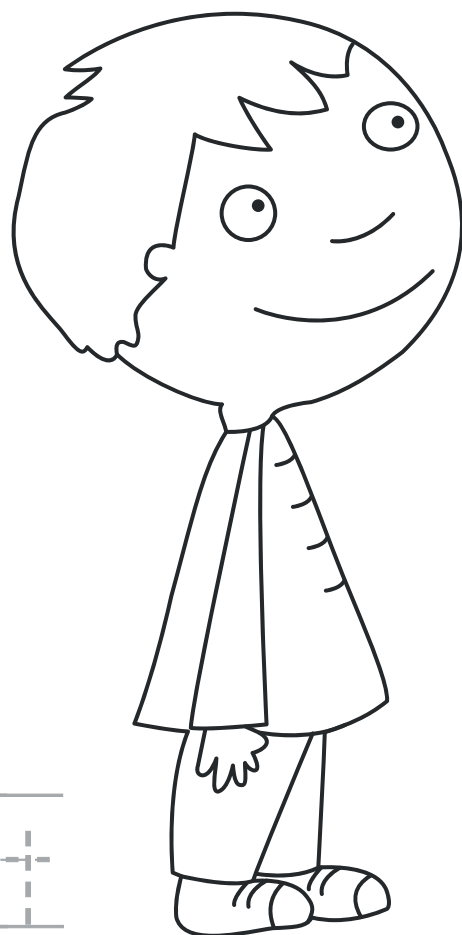

short

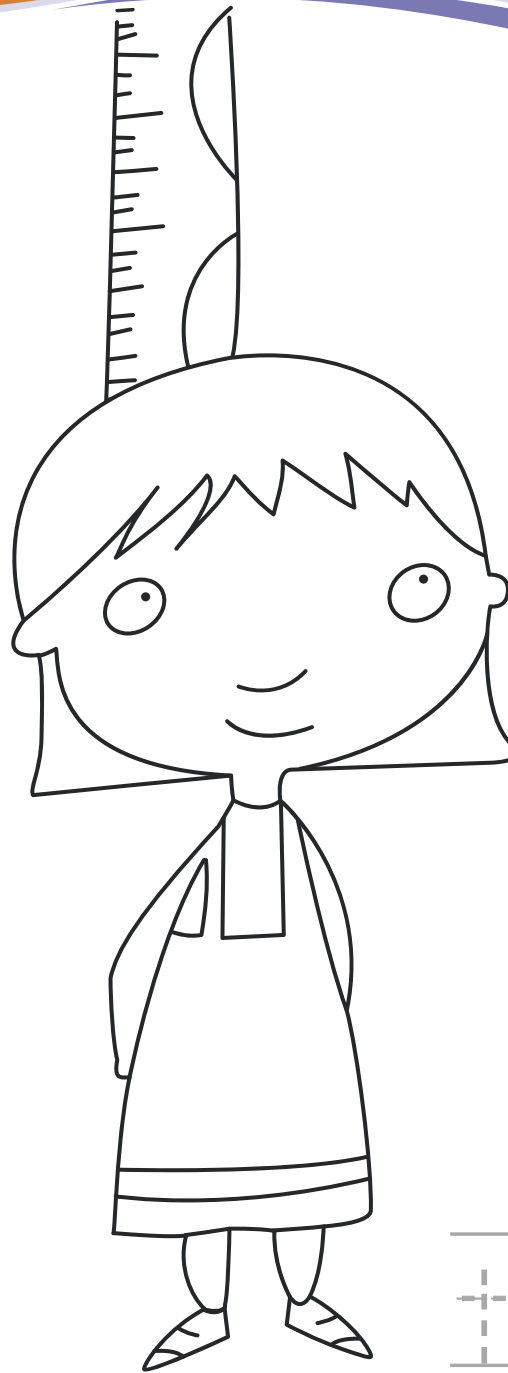

tall







Draw and color.

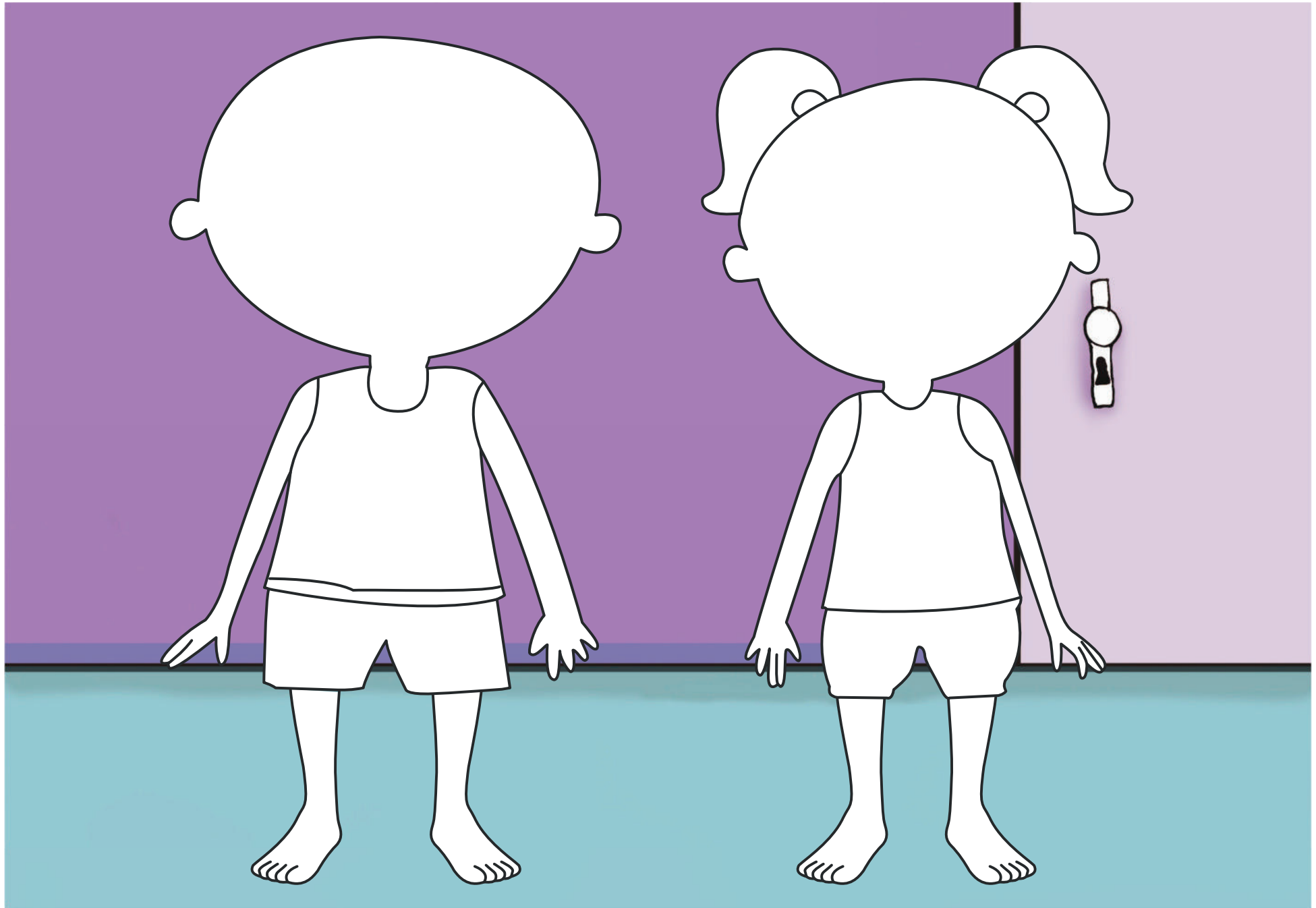



Say, trace, and mark.

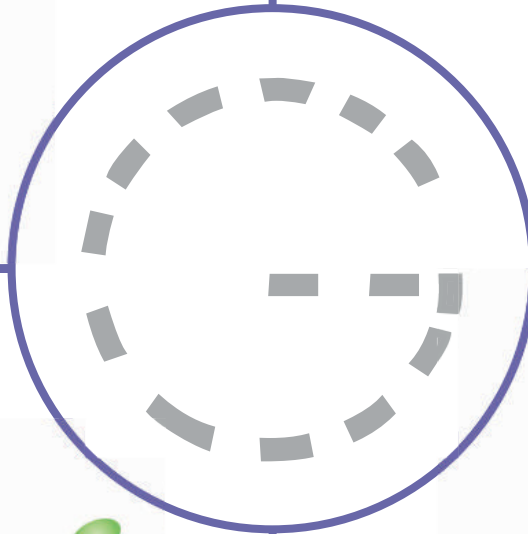
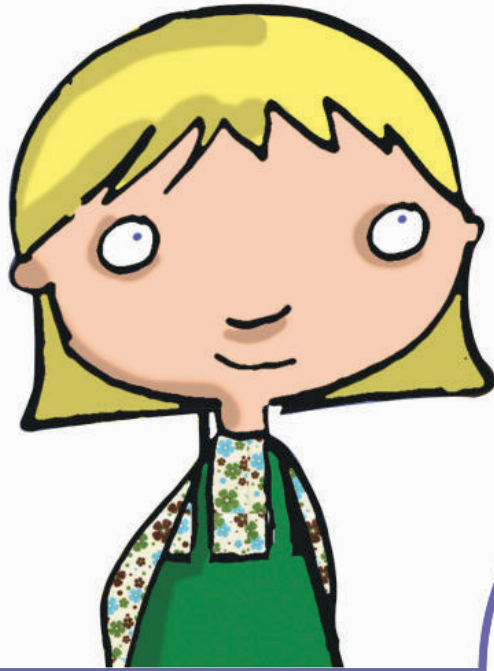



Count and trace.

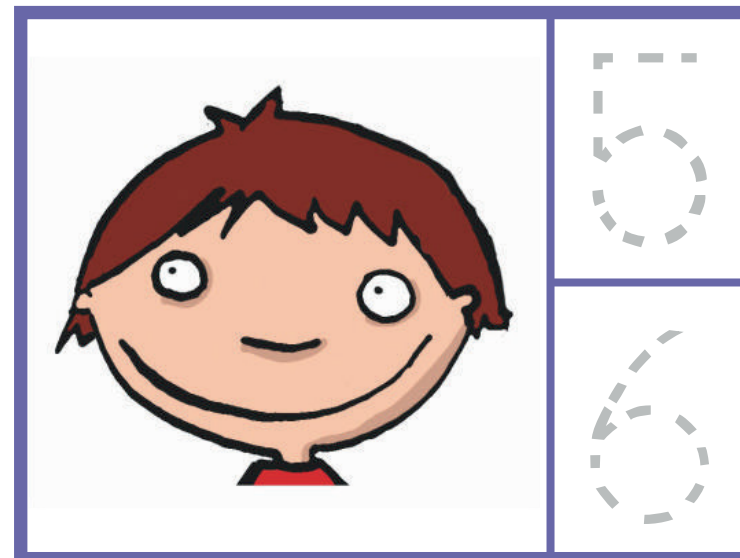
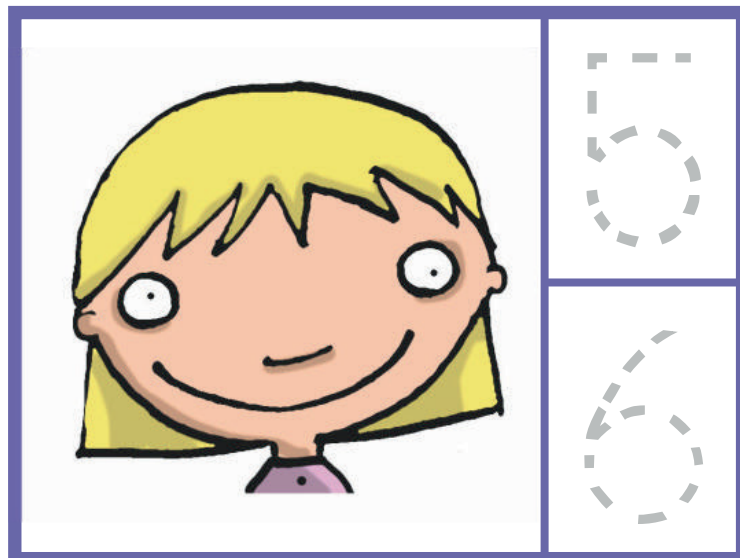



Draw, color, and trace.

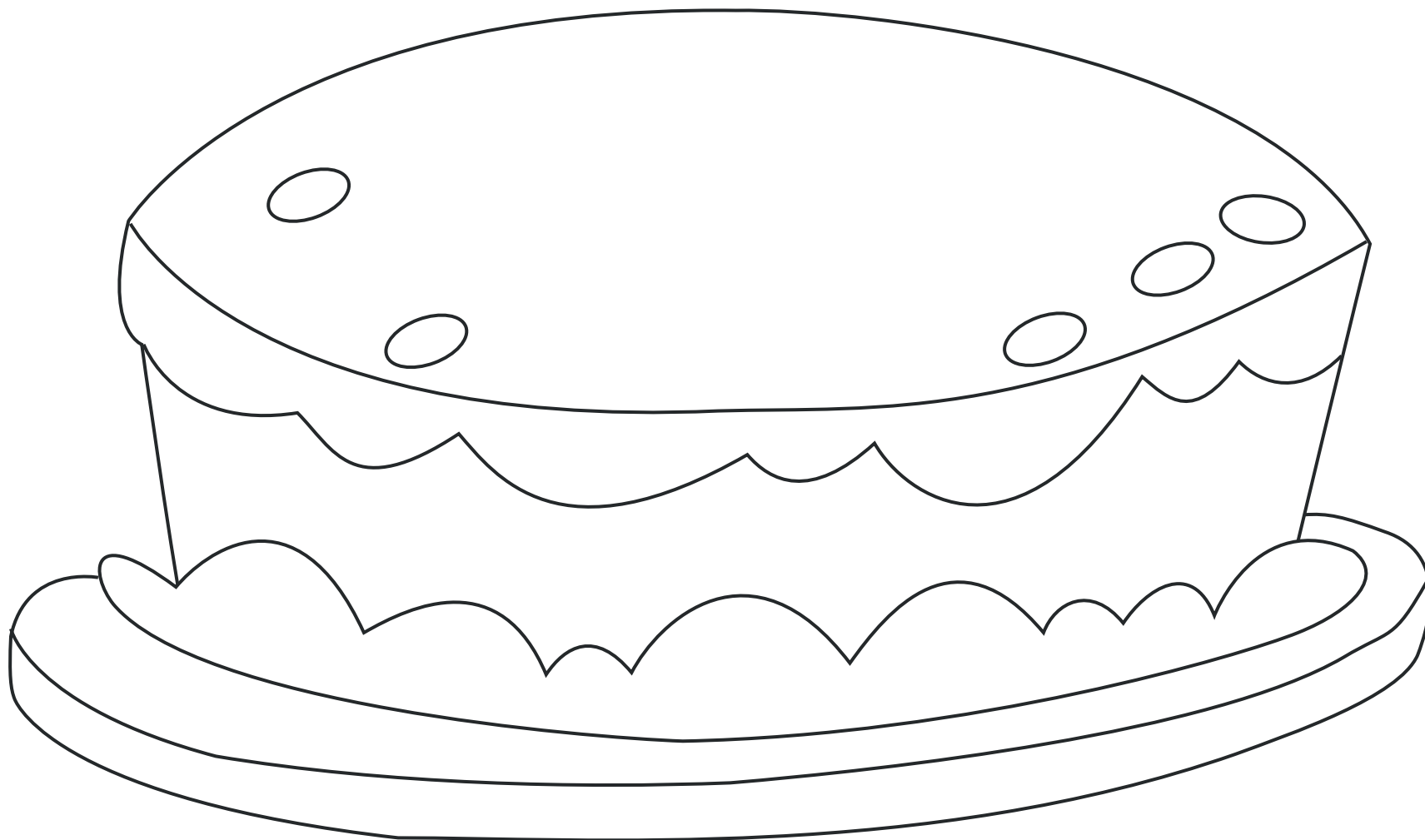

I am years old



Look, color, and say.





Look, listen, and circle.





Look, say, and trace.



building

house



Say, color, and write.

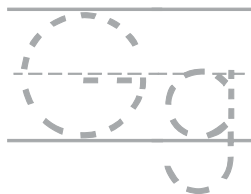
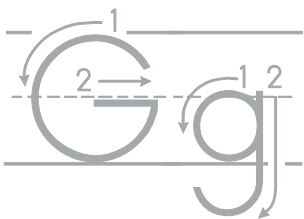
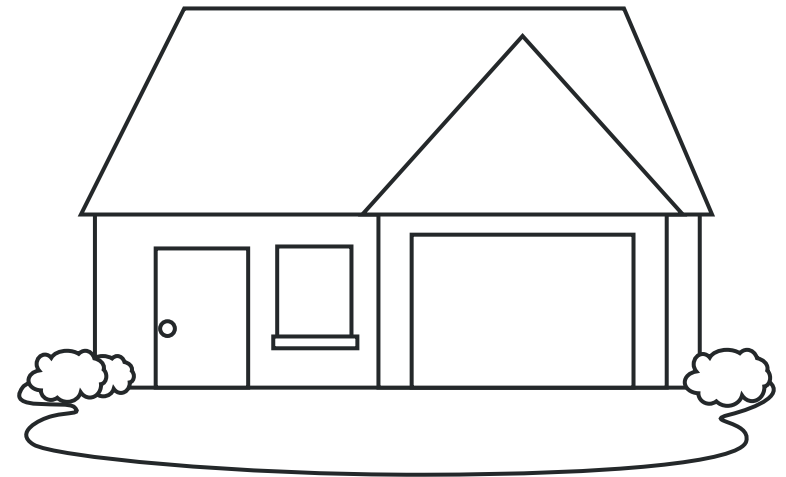
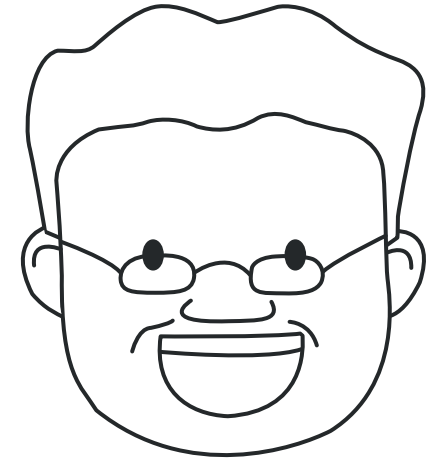

Blank handwriting lines for practicing the letter 'g'.

4  Let's listen!



Color, count, and attach.

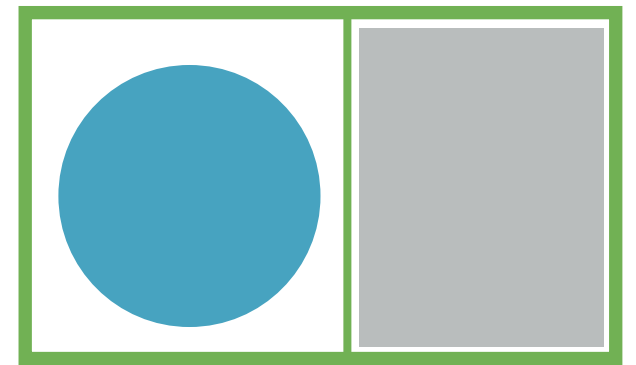
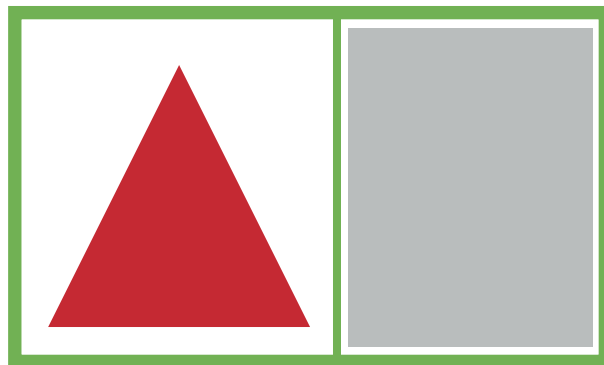
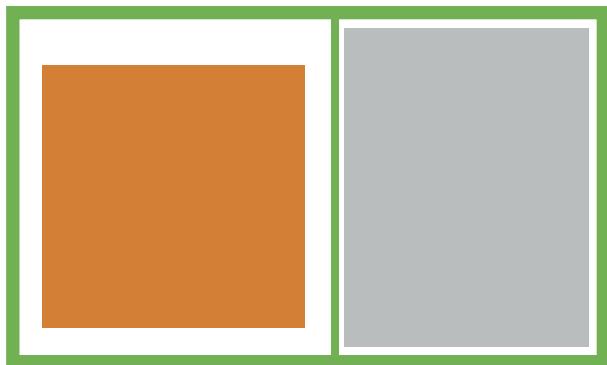



Draw and say.

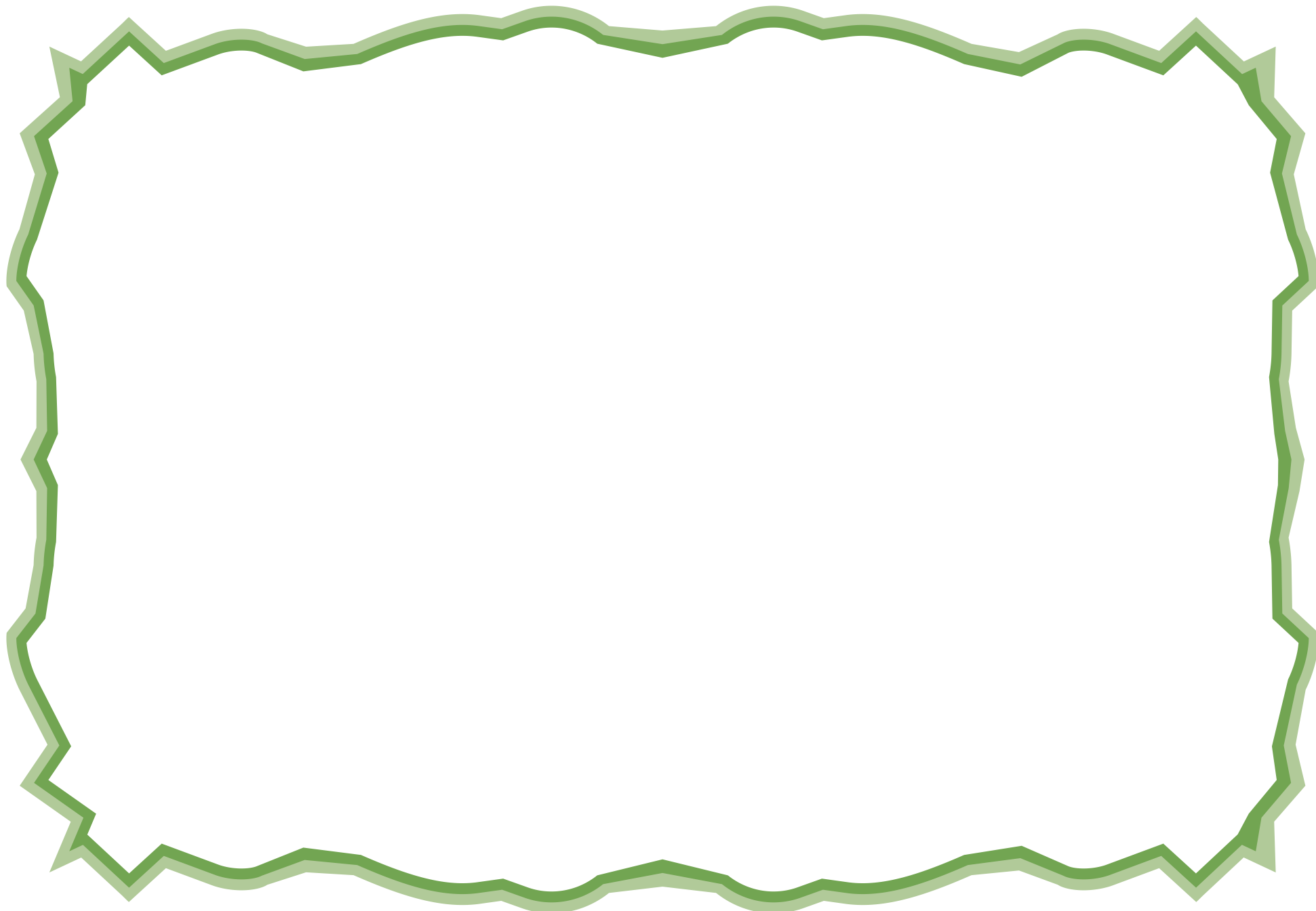



Look and mark.

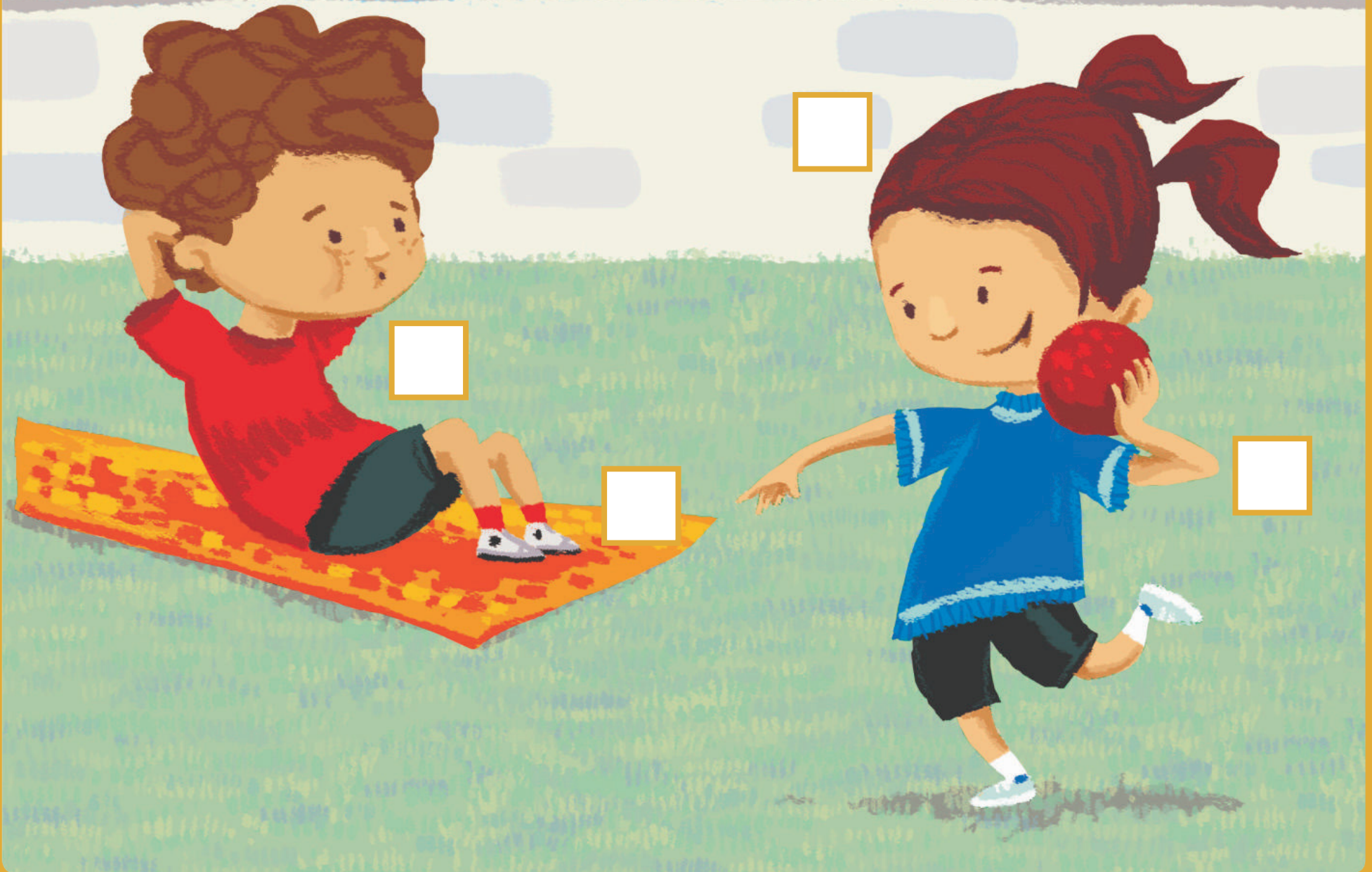



hungry

sleepy

thirsty



Think and mark.





Say, trace, and mark.



Let's listen!



Count and trace.





Find and color.

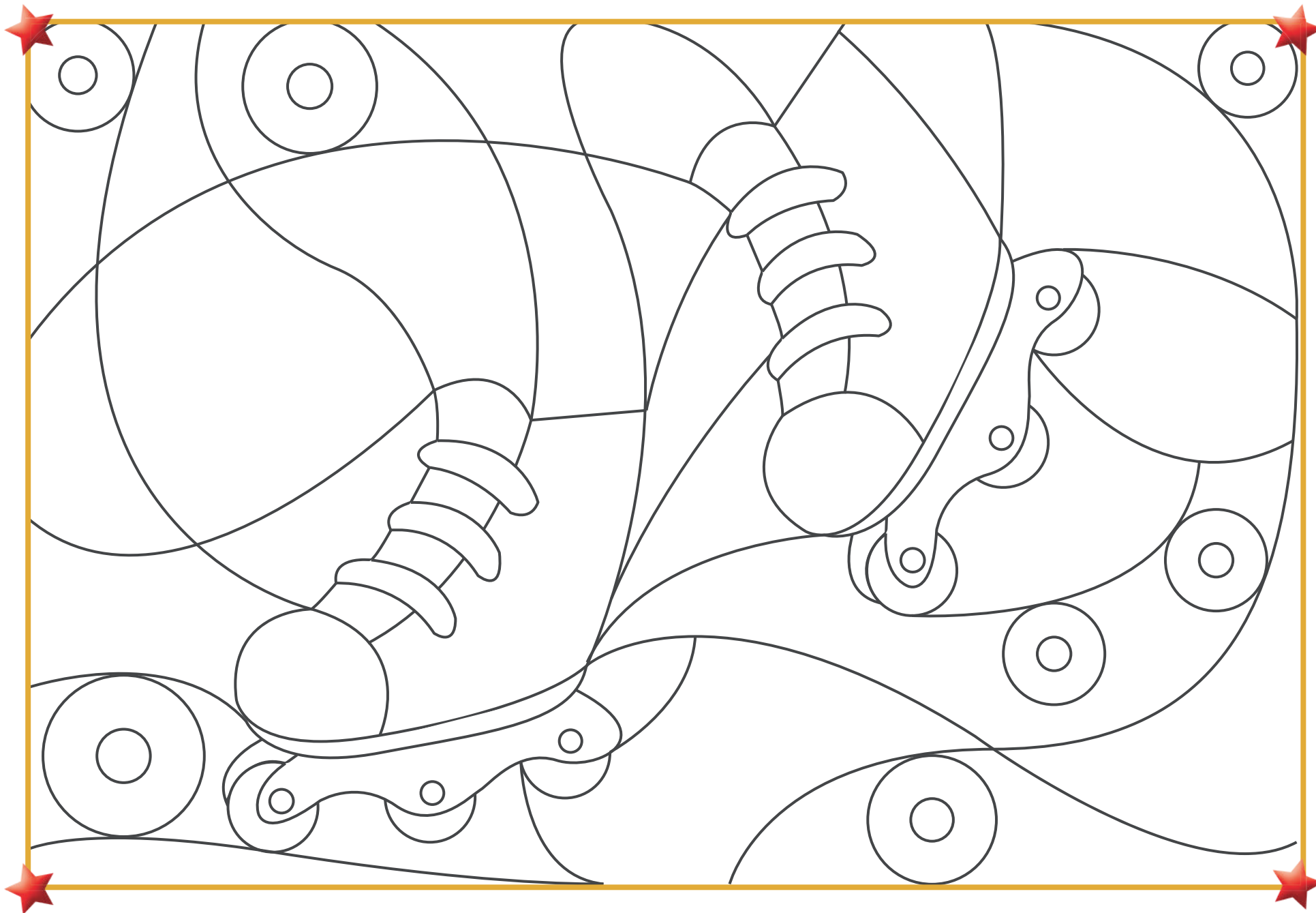



Look and match.



windy



snowy



sunny



rainy





sunny

windy





Look and attach.



spring



summer



winter



fall



Say, color, and write.

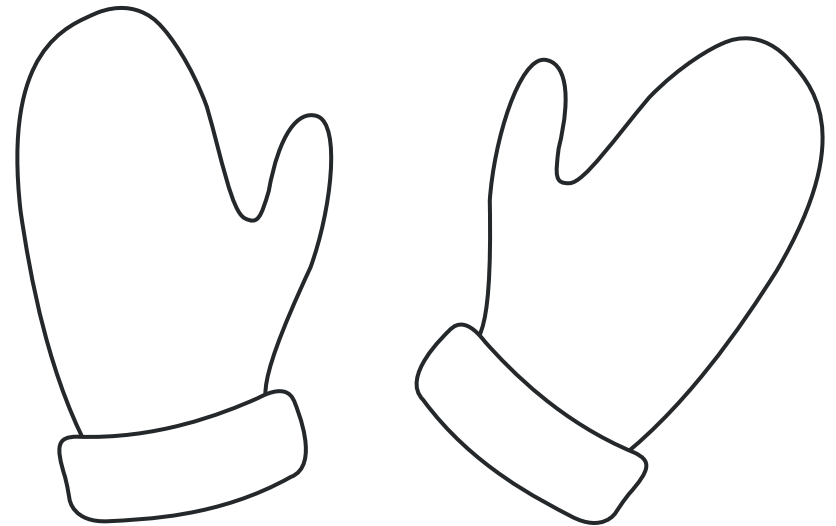
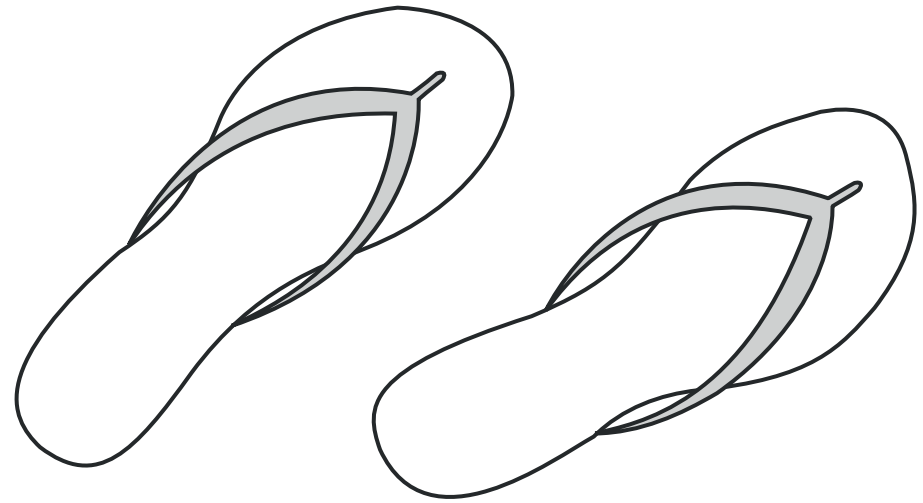

S s S s

Handwriting practice lines for the letter 'S'.

4 Let's listen!



Trace, count, and match.

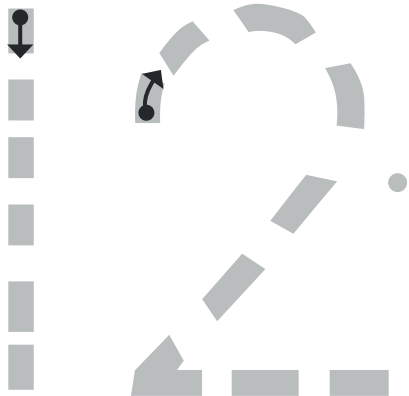
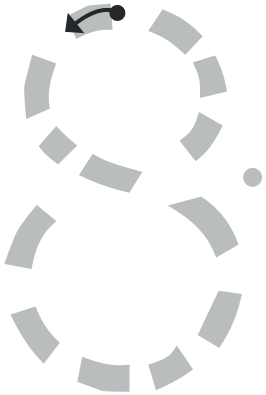
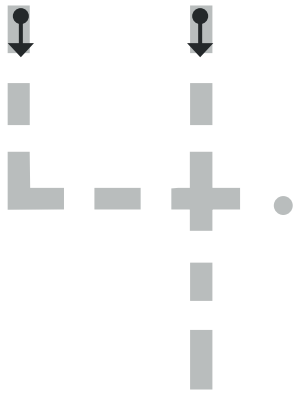



Draw and color.





Look and attach.

desert

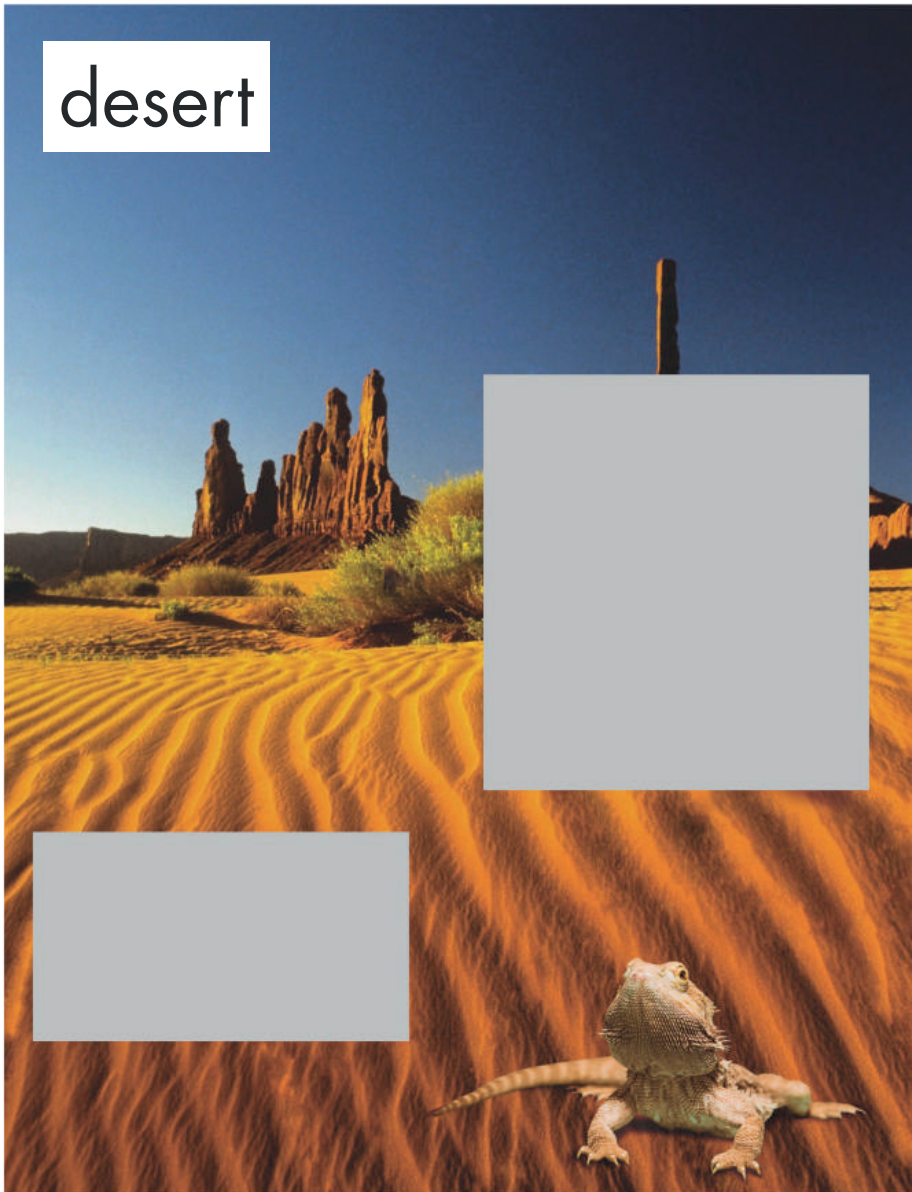

rainforest



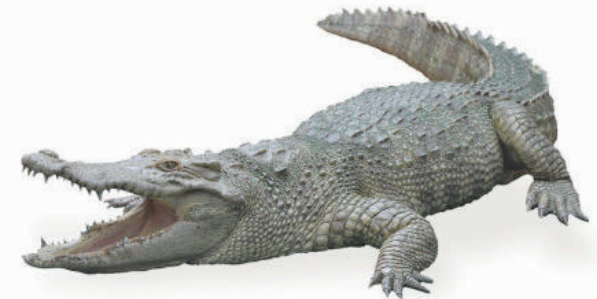

Let's practice!



Trace, look, and match.

swim

fly





Say, trace, and mark.

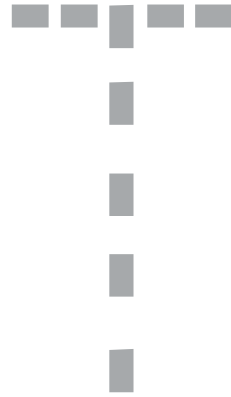

4  Let's listen!



Find, count, and trace.

